



INSTITUTE FOR DEFENSE ANALYSES

## Gradient Index Optics at DARPA

Jeremy Teichman  
Jenny Holzer  
Bohdan Balko  
Brent Fisher  
Leonard Buckley

November 2013  
Approved for public release;  
distribution is unlimited.  
IDA Document D-5027  
Log: H 13-001347



*The Institute for Defense Analyses is a non-profit corporation that operates three federally funded research and development centers to provide objective analyses of national security issues, particularly those requiring scientific and technical expertise, and conduct related research on other national challenges.*

#### About This Publication

This work was conducted by the Institute for Defense Analyses (IDA) under contract W91WAW-09-C-0003 Task DA-2-3226, "Manufacturable Gradient Index (GRIN) Optics," for the Defense Advanced Research Projects Agency's (DARPA) Strategic Technology Office (STO). The views, opinions, and findings should not be construed as representing the official position of either the Department of Defense or the sponsoring organization.

In the event permission is required, DARPA is authorized to reproduce the copyrighted material for use as an exhibit or handout at DARPA-sponsored events and/or to post the material on the DARPA website.

#### Copyright Notice

© 2014 Institute for Defense Analyses  
4850 Mark Center Drive, Alexandria, Virginia 22311-1882 • (703) 845-2000.

This material may be reproduced by or for the U.S. Government pursuant to the copyright license under the clause at DFARS 252.227-7013 (a)(16) [Sep 2011].

INSTITUTE FOR DEFENSE ANALYSES

IDA Document D-5027

## **Gradient Index Optics at DARPA**

Jeremy Teichman  
Jenny Holzer  
Bohdan Balko  
Brent Fisher  
Leonard Buckley



## Executive Summary

---

The Defense Advanced Research Projects Agency (DARPA) asked the Institute for Defense Analyses (IDA) to assemble a summary of work on gradient index optics completed under funding from the Agency. The purpose was to archive the efforts, motivation, and accomplishments that the Agency supported and to provide a reference for any future programs that explore this new area of optics.

Although optical instruments, such as lenses and mirrors, dating back thousands of years ago have been unearthed, lenses were not put into practical use until the invention of eyeglasses in the thirteenth century. The microscope and the telescope were invented in the seventeenth century, but no revolutionary changes occurred in these complex lens systems for the next 200 years. Most lens systems remained homogeneous multi-element systems with spherical glass surfaces and fixed optical properties. Recently, however, new materials and lens designs have been developed, inspired by properties of biological eyes. Materials with a gradient index (GRIN) allow the development of compact systems that have high focusing power while correcting for aberration.

In 2002, DARPA initiated the Bio-Optic Synthetic Systems (BOSS) program, which aimed to synthesize the components of a biologically inspired vision system and demonstrate a level of performance beyond that of standard optical imaging systems (i.e., with reduced size and complexity). Out of more than a dozen exploratory efforts, four efforts were selected for further development and demonstration: fluidic adaptive zoom lenses, foveated imaging, photon sieves, and nanolayer lenses.

As an example, Case Western Reserve University (CWRU) and the Naval Research Laboratory (NRL) collaborated on the nanolayer lens effort to create a synthetic lens that would mimic the structure and capabilities of an octopus eye. The CWRU/NRL team used a forced assembly nanolayer coextrusion process to form films that had a tailored refractive index consisting of thousands of nanolayers of two different polymers that had different refractive indices. The films of various  $n$  were stacked to create a refractive index range ( $\Delta n$ ) and formed into hemispheres, which were combined to form the synthetic bi-convex octopus lens. A zoom lens system constructed from three of these GRIN lenses was demonstrated on a small unmanned aerial vehicle (UAV).

Limited manufacturing capabilities have hindered practical applications of GRIN lenses. In 2008, DARPA initiated the Manufacturable Gradient Index Optics (M-GRIN) program to address GRIN lens manufacturing issues in the development of low-cost,

customizable GRIN-based optics for use in a variety of military systems. This effort included a significant focus on metrology, where new tools were required for monitoring the polymer nanolayer process for GRIN optics. Performers in the M-GRIN program included the following teams:

- University of Rochester (UR) and Optical Polymers International;
- Science Applications International Corporation (SAIC); CWRU; PolymerPlus, LLC; NRL; UR; Columbia University, and Synopsis, Inc.;
- Surmet Corporation; and
- Northrop Grumman (NG) Corporation, NRL, IRFlex Corporation, Rochester Precision Optics (RPO), The Ohio State University (OSU), and Blu Optics, LLC.

Each performer had several manufacturing thrusts within M-GRIN, including process development, process maturation, material development, material characterization, metrology, and GRIN lens design.

Seedling efforts to create arbitrary three-dimensional (3D) GRIN structures were carried out by Pennsylvania State University, Voxtel, Inc., and Corporation for National Research Initiatives (CNRI).

The M-GRIN program has advanced the state of the art significantly and brought large-diameter GRIN lenses within reach for a broader set of optical system designs. Significant hurdles to widespread adoption remain, but the basis has been established for producing niche solutions today and evolving into broader use in the future.

# Contents

---

1.	A Brief History of Optical Instruments .....	1-1
2.	Bio-Inspiration in Optics .....	2-1
	A. Animal Eyes .....	2-1
	B. Bio-Optic Synthetic Systems (BOSS).....	2-4
	1. Fluidic Adaptive Zoom Lenses .....	2-4
	2. Foveated Imaging .....	2-6
	3. Photon Sieves .....	2-8
	4. Nanolayer Lenses .....	2-9
3.	GRIN Lenses .....	3-1
4.	Manufacturable Gradient Index Optics (M-GRIN) Lenses.....	4-1
	A. GRIN Fabrication Techniques.....	4-1
	B. GRIN Lens Fabrication Research in the DARPA BOSS Program .....	4-3
	1. Forced Assembly Nanolayer Coextrusion.....	4-3
	2. GRIN Lens Construction.....	4-4
	C. Considerations Related to the Manufacturing Process.....	4-5
	D. M-GRIN Performers.....	4-7
	1. University of Rochester (UR).....	4-7
	2. Science Applications International Corporation (SAIC).....	4-12
	3. Surmet Corporation .....	4-14
	4. Northrop Grumman Corporation (NG) .....	4-15
	5. Seedling Efforts .....	4-16
	E. GRIN Lens Manufacturing Issues .....	4-19
	1. Environmental Stability of Plastic GRIN Lenses.....	4-19
	2. Residual Stresses from Molding.....	4-19
	3. Coatings.....	4-19
	F. Looking Forward .....	4-20
	Illustrations .....	A-1
	References.....	B-1
	Bibliography .....	C-1
	Abbreviations.....	D-1





# 1. A Brief History of Optical Instruments

---

Optics is the study of the nature of light and the interaction of light with matter, which produces redirection (refraction, reflection), imaging of objects, and breakup of light into constituent components (spectroscopy). The earliest studies in optics were limited to the visible region of the electromagnetic (EM) spectrum (see Figure 1-1) because the available sensors—our eyes—are sensitive to this region. As theoretical investigations guided the exploration of other regions of the EM spectrum and instruments allowed measurements of wider ranges of the spectrum, the universal nature of the phenomena became apparent.

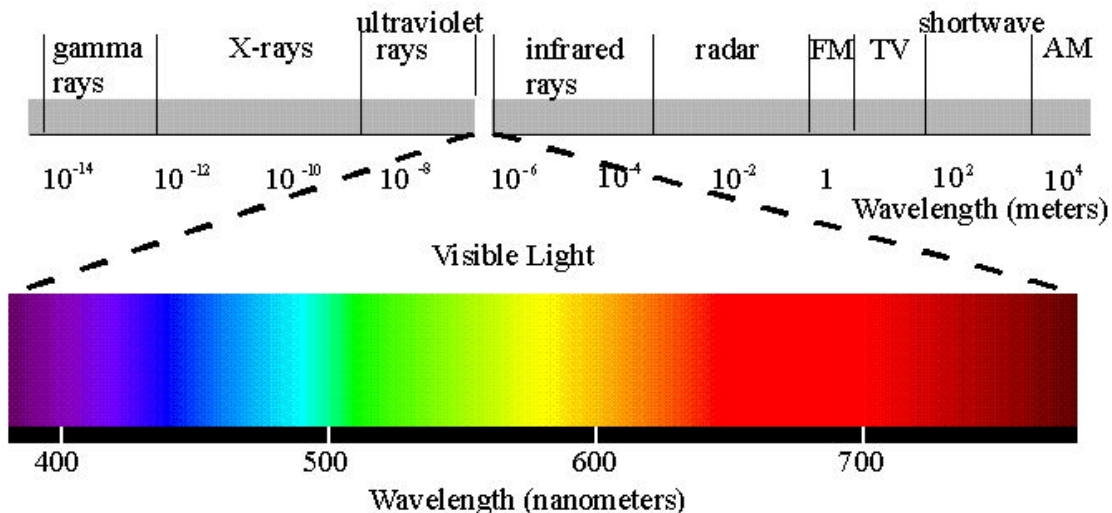

Source: Kaiser (2009).

**Figure 1-1. The EM Spectrum**

**Note for Figure 1-1.** Visible light occupies only a narrow range of the spectrum.

The ancients observed the interaction between light and matter and theorized about the nature of light. The properties of light discovered through their observations were used to explain phenomena and design instruments to control light. In the fifth century B.C., Chinese scholars had discovered that light travels in straight lines. The Greeks (Euclid 300 B.C.) knew about this discovery and about the law of reflection, and both phenomena were later explained by an assertion that light travels by the shortest path between two points (Hero of Alexandria 60 A. D.). The Chinese philosopher Moti recorded the

formation of an inverted image with a pinhole, laying claim to the first mention of the principles behind the pinhole camera (PhotoMoti 2013). Ptolemy’s writings during the first century AD about reflection, refraction, and color formed a significant part of the early history of optics. (Wilk 2004). Early examples of optical instruments are the primitive mirrors made of polished stone (wetted obsidian) from Stone Age Turkey and pre-Columbian Peru. Later, when metallurgy advanced in Egypt and China, mirrors were made from polished metal (silver, bronze (copper and tin), and so forth). Pieces of glass covered with lead were discovered in Roman graves from the second century, indicating that the Romans introduced glass mirrors in the first century A.D. and manufactured them by finishing with a metallic layer. See Figure 1-2(a)–(c)

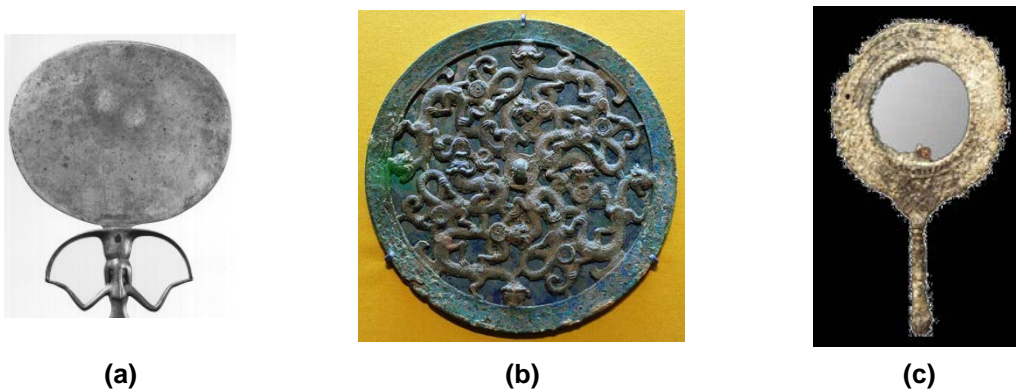

Source: (a) Brooklyn Museum Website (2011); (b) DAWN Media Group (2013); (c) “The History of Mirrors” (n.d.).

**Figure 1-2: Examples of Ancient Mirrors:  
 (a) Egyptian Silver/Copper Alloy, (b) Chinese Bronze, (c) Roman Glass**

The earliest identified lenses are from the IV/V Dynasties of Egypt, dating back about 4,500 years ago. The Assyrian lenses (700 B.C.), such as the Layard/Nimrud lens (see Figure 1-3(a)), is considered by some to be the oldest lens in existence. However, its origin and purpose is unknown. Another lens, possibly from the fifth century B.C. found in Crete is more powerful and of far better quality than the Nimrud lens. Roman writers Pliny and Seneca refer to a lens used by an engraver in Pompeii possibly for magnification. The ancients perhaps used lenses for many purposes about which we are not aware. However, it is difficult to specify the time or even the general era of origin of optical objects since they could easily be mistaken for ornaments or other items without recognizing their true purpose. Hundreds of years before the Dutch supposedly invented the telescope in the late sixteenth century, the Vikings could have been using this instrument. This remarkable possibility has emerged from a study of sophisticated lenses from a Viking site on the island of Gotland in the Baltic Sea (see Figure 1-3(b)). (Schmidt, Wilms, and Lingelbach 1999). Consider the image in Figure 1-3(c). Is it a magnifying

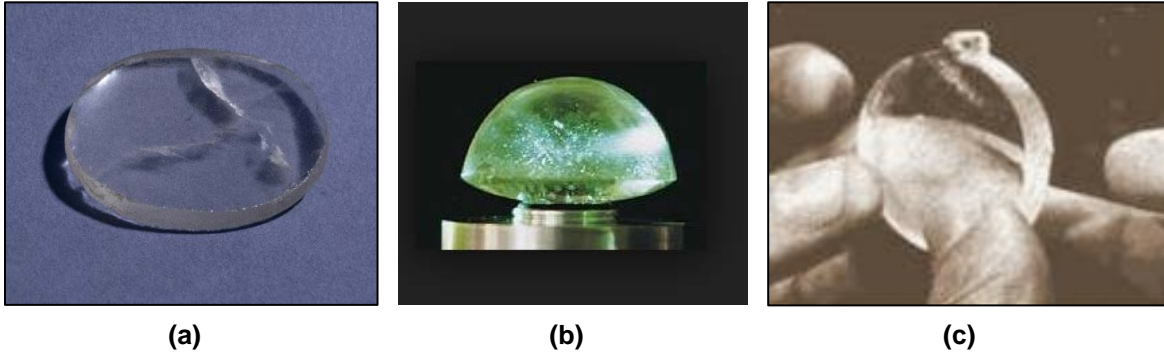

Source: (a) The British Museum (n.d.); (b) Whitehouse (2000); (c) Tracking Ancient Man (2012).

**Figure 1-3. Ancient Lenses:**  
**(a) Layard/Nimrud Lens, (b) Viking Lens, (c) a Magnifying Lens or an Ornament**

lens or an ornament? The existence of lenses in ancient Greece is often questioned despite the fact that Aristophanes describes one in his play *The Clouds* (423 B.C.). “The Roman tragedian Seneca [4 B.C.–65 A.D.] is alleged to have read ‘all the books in Rome’ by peering at them through a glass globe of water to produce magnification” (Drewry 2007).

One of the first known applications of a lens was the so called “reading stone,” a hemispherical flat-bottomed lens used for enlarging print for people with presbyopia, a condition in which the eye exhibits a diminished ability to focus on near objects (see Figure 1-4(a)). Reading stones manufactured from quartz were developed in the eighth century. Later, reading stones were designed based on the theories of the Arabic astronomer and mathematician Alhazen in the eleventh century, following the Romans’ discovery of the process for converting sand into glass (Silvestri, Molin, and Salviulo 2006), which could then be shaped into lenses and polished. The reading stone was useful but cumbersome because the lens had to be moved over the document to read it. Two centuries after the reading stone was introduced, the idea of attaching lenses directly under the eyes became popular and gave rise to the next step in vision-correction optics—spectacles—in Italy in 1260. In the Middle Ages, wearing spectacles signified knowledge and learning, and it became popular in paintings of the time (see Figure 1-4(b)). It is not clear who designed and manufactured the first spectacles, although the English Franciscan Friar Roger Bacon (1214–1294), who is considered by many as the first modern scientist, is often credited with their invention.

The idea of contact lenses goes back to Leonardo da Vinci in 1508. He was interested in studying a method for directly altering corneal power by submerging the eye in a bowl of water, but not for correcting vision. René Descartes proposed another idea to correct vision in 1636: use a glass tube filled with liquid and place it in direct contact with the cornea. Despite the practical problems with this idea, Thomas Young (1801)



(a)

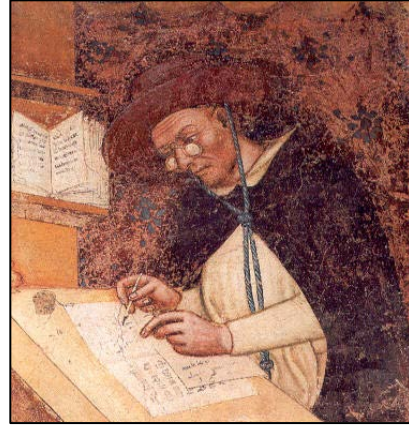

(b)

Source: (a) Drewry (2007); (b) New York Carver (2012).

**Figure 1-4. (a) Reading Stone Used to Magnify Print;  
(b) Spectacles Used to Read Manuscripts**

**Note for Figure 1-4(b):** This figure is a 1352 fresco by Tommaso da Modena showing the Dominican monk Hugues de St.-Cher copying a manuscript.

made a basic pair of contact lenses based on this idea. It was not until 1887 that a German ophthalmologist, Adolf Fick, made the first contact lenses from blown glass and successfully fitted these lenses to the eyes. (Siviglia 2010)

Another advance in optical instrumentation came when Da Vinci expanded on the principles of imaging through a pinhole and provided detailed descriptions and illustrations of the camera obscura (see Figure 1-5(a)) in his *Codex Atlanticus* (1485). This camera was a predecessor to the pinhole camera that projects an image on a screen for viewing or drawing (see Figure 1-5(b)). Pinhole cameras have limitations. They have no lenses and thus little light-gathering capability; therefore, they require long exposures. Despite these limitations, they are still manufactured and used for special effects. Pinhole cameras have unlimited focus and thus have infinite depth of field (see Figure 1-5(c)).

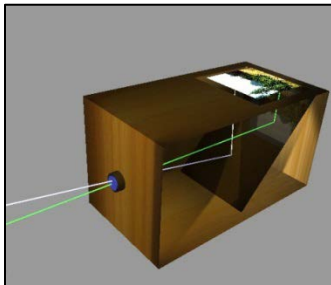

(a)

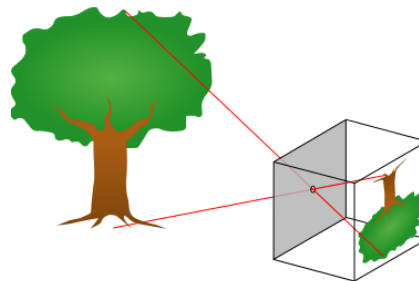

(b)



(c)

Source: (a) Wikipedia (2013b); (b) Wikipedia (2013d); (c) Rodrigues (2010).

**Figure 1-5. (a) Camera Obscura; (b) Principle of a Pinhole Camera;  
(c) Image from a Modern Pinhole Camera Showing Infinite Depth of Field**

During the seventeenth century, one of the fundamental problems in optics was solved after more than 1,500 years of investigation. In 1621, Willebrord Snell was credited with experimentally discovering the law of refraction, although this discovery was uncovered in the unpublished papers of Thomas Harriot long after his death in 1621. In 1637, Descartes published the present form of this law, a basis of modern geometric optics known as Snell's Law (Fishman 2000, 405, 408) (see Figure 1-6). At about this time (1657), Pierre de Fermat rederived the law of refraction using his principle of least time of travel for light to get from one point to another. This theoretical understanding of the propagation of light between different materials allowed the design of optical systems based on rigorous calculations and also provided the impetus for the discovery of many fundamental theories of light propagation and optical phenomena throughout the rest of the century.

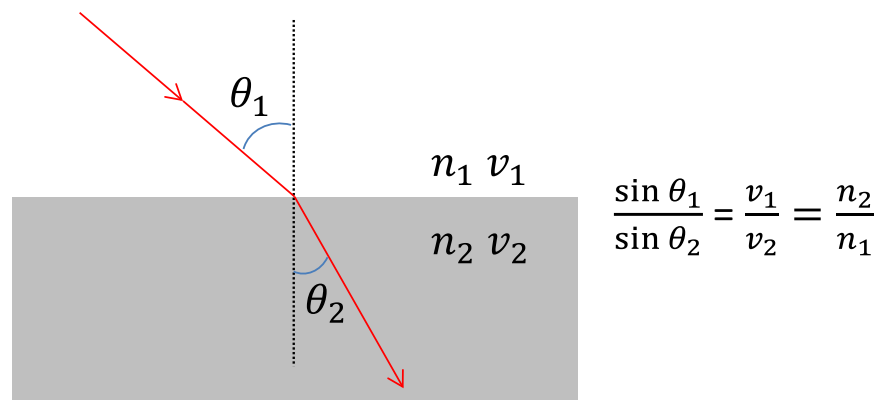

**Figure 1-6. Snell's Law**

**Note for Figure 1-6:** If  $n_2 > n_1$ , the velocity in the higher index medium,  $v_2$ , will be lower than the velocity in the lower index medium  $v_1$ , and  $\theta_2$  will be less than  $\theta_1$ .

Although both lenses and mirrors were known to the ancients, it was not until the seventeenth century (although before the quantification of the law of refraction) that systems of multiple lenses working together began to appear, leading to the invention of the telescope and the microscope. Hans Lippershey is credited with inventing the first working telescope (1608) and a patent application for the design. The design consisted of a convex objective lens and a concave eyepiece. Galileo Galilei used this design to study the heavenly bodies and devoted himself to improving and perfecting the telescope design, improving the 3x magnification of early telescopes to 33x. Johannes Kepler altered the original design by using a convex-lens objective but with a convex eyepiece. This design became popular with astronomers such as Christaan Huygens, who constructed the first powerful working telescope using Kepler's design. Modern eyepiece designs are significantly more complex, such as the 8-lens Albert Nagler eyepiece (1981). See Figure 1-7.

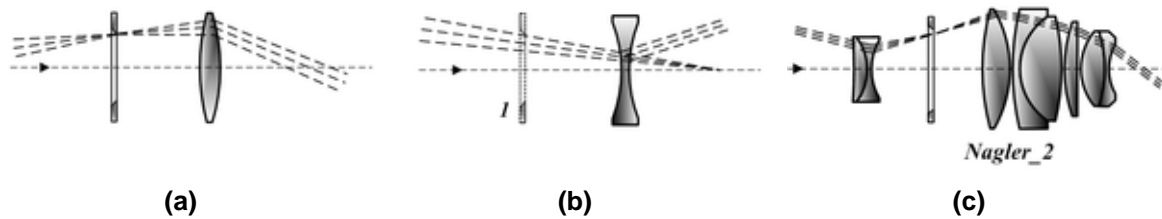

Source: Wikipedia (2013c).

**Figure 1-7. Eyepiece Designs: (a) Convex (Kepler), (b) Negative (Galileo), (c) Nagler**

Around the time of the telescope's invention, the father-and-son team of Zacharias and Hans Janssen (1590) experimented with multiple lenses placed in a tube. They observed that objects appeared greatly enlarged when placed in front of the tube. Further developments to this system allowed the first study of cells (1661) by Robert Hooke and the first observation of bacteria (1676) by Anton van Leeuwenhoek. Leeuwenhoek also invented new and improved methods of grinding and polishing lenses, which led to magnifications of up to 275x. Further technical innovations resulted in the microscope becoming a favorite instrument for studying nature at the limit of optical capabilities. This limit was identified by Ernst Abbe (1872), who provided calculations and experimental verification of a formula for the maximum possible resolution for common optical microscopes. This limit was pushed with the Richard Zsigmondy's (1903) development of the ultramicroscope, which allowed viewing objects below the wavelength of light by observing scattered light instead of reflected light.

Isaac Newton, inspired by his observations of chromatic aberrations in the lenses of refracting telescopes, began his study of the dispersion of light in 1666. He described the splitting up of white light into a multi-colored spectrum when passed through a prism and the recombination into white light by passing through a second prism. Newton concluded that color is an intrinsic property of light. Convinced that any glass lens would suffer from chromatic aberration, Newton used mirrors to build the first reflective telescope in 1668. He later reported his theory of light and colors to the Royal Society, stating that white light is composed of light of different colors and each color is refracted by glass to different extents (1675).

The correction of chromatic aberration in refractive systems awaited the development of new lens materials. Until the seventeenth century, optical designers used crown glass produced from alkali-lime silicates with approximately 10% potassium oxide. At the time that Newton was rejecting the achromatic glass lenses, new optical materials were being developed. Introducing lead (Pb) to the glass recipe created a "flint" glass with light dispersive power twice that of crown glass. Early flint glasses contained from 4 to 60% lead oxide. However, in modern times, flint was recognized as a source of pollution because of the lead content, and the lead was replaced with titanium and zirconium oxides. Lens systems are typically made of a combination of lenses of different materials,

which are combined for special purposes, such as reducing chromatic aberration, as shown in Figure 1-8.

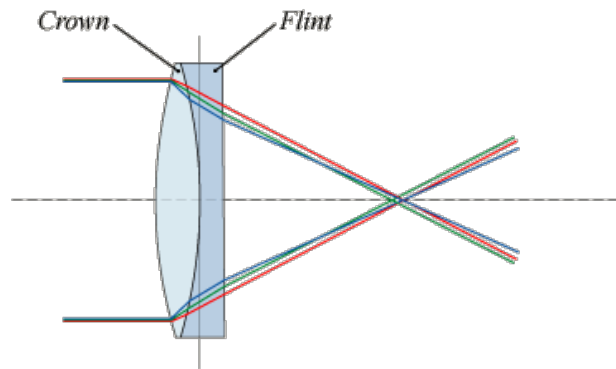

Source: Wikipedia (2013a).

**Figure 1-8. An Achromatic Doublet Formed from a Concave Flint Glass Element with High Dispersion and a Convex Crown Glass Element with Lower Dispersion**

Lenses can also be made of a liquid in a rigid container, as in Seneca’s glass-filled globe mentioned previously. Nineteenth century researcher Peter Barlow worked on achromatic lenses for telescopes, using carbon disulfide as the liquid lens element between glass lenses. Carbon disulfide is a colorless liquid with an index of refraction that is close to that of the best flint and a dispersion that is double that of flint. He designed a combination of lenses. When this combination of lenses is placed in front of an eyepiece in a telescope, the eyepiece’s focal length is effectively decreased by an amount now known as the Barlow’s divergence. This decrease in focal length effectively increases the magnification of the image. Barlow’s largest fluid lens telescope was completed in 1832 in collaboration with the optician George Dollond. The Barlow lens, a derivative of this work, is still widely used today (see Figure 1-9).

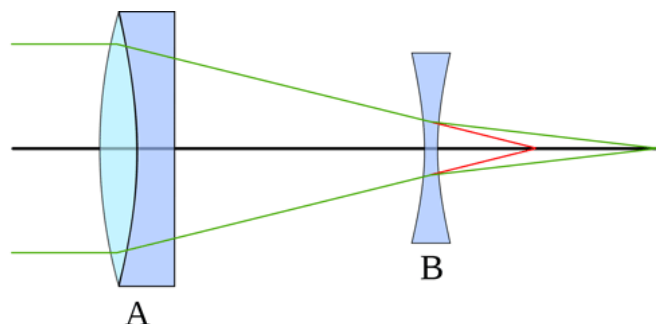

Source: Wikimedia Commons (2013a).

**Figure 1-9. Ray Trajectory without (Green) and with (Red) Barlow Lens**

The twentieth century saw no revolutionary changes in lens systems. Most systems remained homogeneous multi-element systems with spherical glass surfaces and fixed optical properties (Zuccarello et al. 2002). Recent decades, however, have seen the development of new materials. These new materials and the lens designs inspired by properties found in biological eyes will be the focus of the remainder of this document. In particular, materials in which the refractive index varies within the material are modeled after biological optical systems such as our own eyes. These gradient index (GRIN) materials can more compactly provide high focusing power while correcting for aberration than can conventional optical systems. The process of manufacturing lenses from GRIN materials remains a challenge in many applications.

This document will discuss the contributions of two Defense Advanced Research Projects Agency (DARPA) programs that sought to design a biologically inspired imaging system and to make the associated technology one that could be manufactured. The first program, Bio-Optic Synthetic Systems (BOSS) identified several promising biomimetic systems and in particular one that used a GRIN lens. The second program, Manufacturable Gradient Index Optics (M-GRIN), expanded on the development of the GRIN lens and examined the process of making these types of lenses manufacturable.



## 2. Bio-Inspiration in Optics

### A. Animal Eyes

Modern conventional, high-quality optical systems may have many individual lens elements. The ability to change focus requires that these lens elements can move relative to one another. As a result, high-quality conventional, large-aperture optical systems are often complex, bulky, and heavy.

Biological optical systems—the living eyes of animals and insects—have evolved over hundreds of millions of year to provide increasing performance in relatively small structures. Further advancements in optical system design may rely on exploiting what has been developed by nature.

Evolution has converged on eight distinct types of biological optical systems (Land and Nilsson 2002) (see Figure 2-1). These systems fall into two general classes of eye structure: the single-chambered camera-like eyes of vertebrates and cephalopods and the compound eyes of invertebrates.

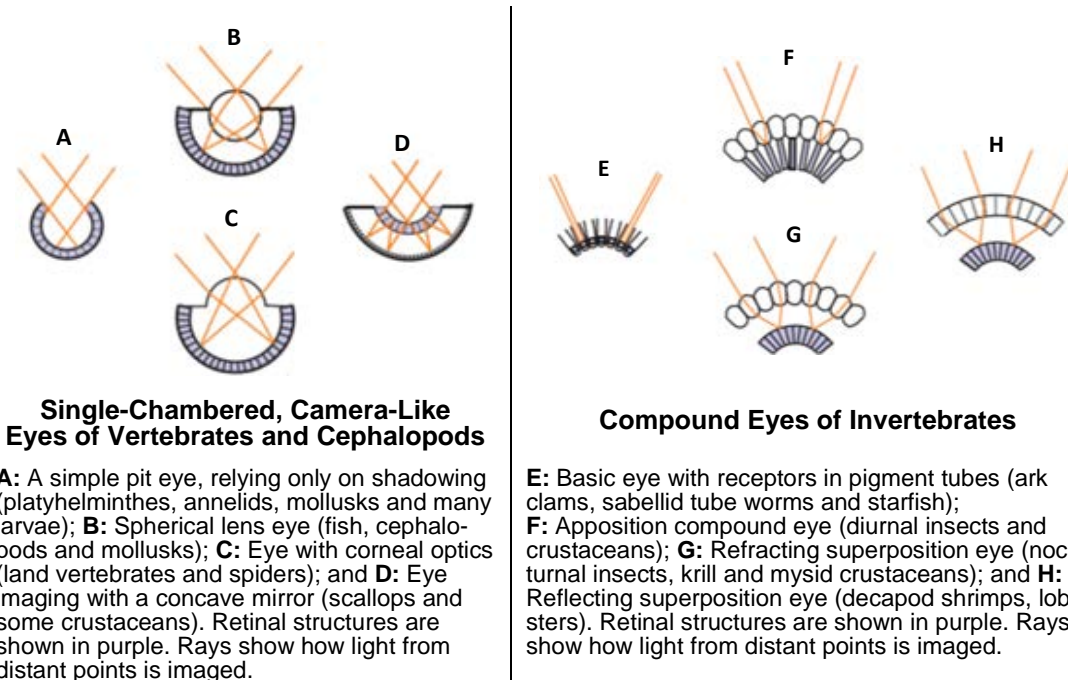

Source: Land (2005), R319, R321.

Figure 2-1. Eight Types of Animal Eyes

The simplest of the single-chambered eyes is the pit eye (see Figure 2-1A), which consists of a small number of light-responsive receptors in a pigmented pit. This ancestor of more optically advanced eyes relies only on shadowing to allow the organism to deduce the angle of incoming light and is still present in flatworms, mollusks, and many larvae. Enlarging the cup and reducing the aperture of the pit eye creates a pinhole eye. The smaller aperture enables more directional light to reach the photoreceptors and causes less interference, which increases the resolution of the image. However, since this decreased aperture lets in little light, the images are darkened. This pinhole eye design is found in the evolutionary relic *Nautilus*.

The octopus and squid are close relatives of the *Nautilus*, but unlike the *Nautilus*, their eyes have developed lenses. In marine animals, the most common optical system in single-chambered eyes is based on a spherical lens (see Figure 2-1B). Lenses with spherical surfaces suffer from a defect known as spherical aberration: the light hitting the different parts of the lens is focused at different points, creating a blur circle rather than a sharp image. More advanced lens eyes solve this focus problem by having an inhomogeneous construction with dense high-refractive index material in the center and a gradient of decreasing density and refractive index toward the periphery. The presence of this gradient means that rays of light are bent continuously within the lens, causing the focal length of the eye to be about 2.5 lens radii, much shorter than the 4 lens radii of a homogeneous lens (Land 2005). This GRIN is a result of the layered structure of the lens, where each deeper layer of cells has a slightly higher concentration of protein and, thus, a higher refractive index (Zuccarello et al. 2002, 1261). The lens of the fish, for example, is spherical with a GRIN that varies from approximately 1.36 at the edge to 1.55 at the core (Garner et al. 2001, 973). Lenses with this construction are found not only in fish and cephalopods other than the *Nautilus*, but also in many gastropod mollusks. In simple optical systems such as the fish lens, the focal length is a function of the wavelength of light. This distortion is called chromatic aberration. Despite this aberration, many fish have excellent color vision. The problem is solved by subtly varying the wavelength and position dependent refractive index gradient to produce multiple focal lengths (Kroger et al. 1999, 361).

In the optical systems of the aquatic animals discussed thus far, the lens is entirely responsible for image formation. The cornea for aquatic animals serves as simply a transparent cover since there is not a major difference in the refractive index of the cornea vs. that of the surrounding water. For land animals, however, the curved air/cornea interface acts as the main imaging-forming component of the eye (see Figure 2-1C). The main function of the lens is for focusing at different distances. This focusing is typically accomplished by changing the shape of the lens by using muscles attached to the periphery. An eye of this type corrects for spherical aberration in two different ways: the cornea

might be aspherical or the lens might be inhomogeneous. See Figure 2-2. The human eye uses both of these solutions (Millodot and Sivak 1979).

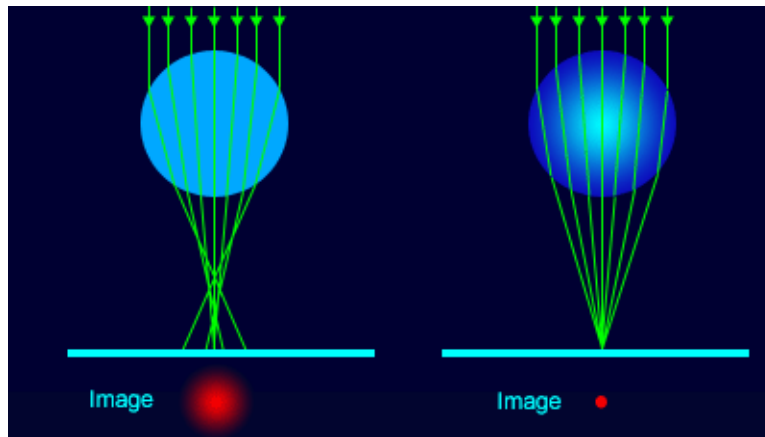

Source: Deep Ocean Diving (2005).

**Figure 2-2. Spherical Aberration (Left) and the Solution for It in the Fish Eye Crystalline Lens: Decreasing Refractive Index from the Center to the Surface**

Only the scallop provides an example of the final type of single-chambered eye (see Figure 2-1D). To form an image, this eye uses a spherical silvery concave mirror much like a Newtonian telescope.

The compound eyes found in about half of the animal kingdom species are constructed of many optical systems rather than a single system in the eyes already described. Proto-compound eyes, such as those found in tube worms (see Figure 2-1E), are the compound version of the simple pit eye and respond only to shadow. The apposition eye (see Figure 2-1F) is the most common type of compound eye. Here, each receptor or small cluster of receptors has its own lens. This basic element of spatial resolution, called the ommatidium, produces a tiny inverted image. The brain sees an overall erect image constituted from the apposed fields of view (FOVs). Apposition eyes are found in insects (e.g., bees and grasshoppers) and in crabs.

The resolution of compound eyes is limited by diffraction. The smaller the lens diameter, the larger the interference pattern and, thus, the more blurred the image. An improvement in resolution would require a greater number of ommatidia and an increase in the lens diameter of each of them, which, however, quickly results in an absurdly sized eye structure (Land and Fernald 1992, 16).

A second type of compound eye, the superposition eye, increases resolution by superimposing the light of many optical elements onto the receptors. Since the receptors of superposition eyes receive orders of magnitude more light than those in an apposition eye, these eyes are common in nocturnal insects (e.g., fireflies, see Figure 2-1G) and deep-water crustaceans (e.g., lobsters, see Figure 2-1H).

The preceding introduction to the physical structure of biological optical systems highlights designs that are provided by nature and may serve as inspiration for synthetic systems. In particular, these biological designs are extremely compact and allow for wide FOV and control over spherical and chromatic aberration.<sup>1</sup>

## **B. Bio-Optic Synthetic Systems (BOSS)**

In 2002, DARPA initiated a program aimed at simplifying complex optical sensors, such as those often used in military operations, by imitating biological systems. The goal of the BOSS program was to understand and synthesize the components of a biologically inspired vision system that would demonstrate a level of performance beyond standard optical imaging systems, with reduced size and complexity. The BOSS program was a multi-disciplinary effort that combined biology, chemistry, and optics.

The initial phase of the BOSS program funded more than a dozen exploratory efforts to create technology that would allow the dynamic control of lens shape and the control of index of refraction to create a lens that would provide a wide FOV with no moving parts. Four of these initial efforts were selected for further development and demonstration in a system: fluidic adaptive zoom lenses, foveated imaging, photon sieves, and nanolayer lenses.

### **1. Fluidic Adaptive Zoom Lenses**

The human eye focuses by changing the shape of the lens, thereby altering its refractive power. This feature of the eye inspired a team of researchers from the Rockwell Science Center (Thousand Oaks, California), the Massachusetts Institute of Technology (MIT) (Cambridge, Massachusetts), the University of California – San Diego (San Diego, California), and AeroVironment (Monrovia, California) to explore the development of a shape-changing microfluidic lens. The team's lens consisted of a 20-mm diameter, 4-mm deep fluidic chamber constructed from polydimethylsiloxane (PDMS) covered by a thin (30- to 100- $\mu\text{m}$ ) PDMS membrane and bonded to a thin (150- $\mu\text{m}$ ) glass slide. The PDMS structures were fabricated using a soft lithography process and then bonded together and to the glass by an oxygen plasma bonding technology. A mini-pump was used to inject fluid into the chamber and deform the membrane into a convex shape. Radius of curvature decreased with increasing pressure, causing a reduction in the focal distance of the lens (Zhang et al. 2003, 3171). The refractive index of the lens could be changed depending on the refractive index of the liquid injected.

The team later extended its designs to more complex structures. By using two independently controlled fluidic chambers placed back-to-back, not only could the lens

---

<sup>1</sup> For a discussion of all known types of eyes in the animal kingdom, the details of their structure, and the physical principles of their function, the reader is referred to *Animal Eyes* (Land and Nilsson 2002).

properties be tuned, but different lens types, such as planoconvex, planoconcave, biconvex, biconcave, positive meniscus, and negative meniscus, could also be formed (see Figure 2-3) (Zhang, Justis, and Lo 2004, 4194).

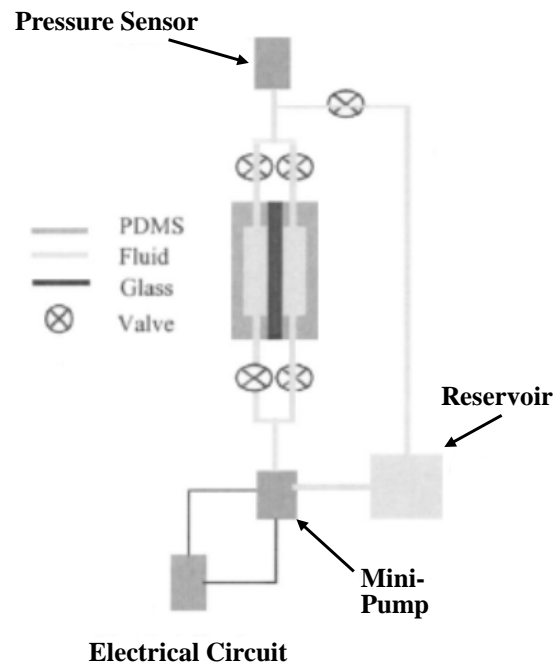

Source: Zhang, Justice, and Lo (2004), 4194.

**Figure 2-3. Fluidic Adaptive Lens of Transformable Lens Type**

The wide focal length tunability and lens type convertibility of this structure enabled new designs for zoom lenses, where zooming is achieved without varying the distance of the lens. Since this fluidic adaptive lens is capable of achieving convex-concave, convex-convex, and concave-convex configurations, this capability suggests that reverse telephoto and telephoto systems can be integrated into the same adaptive lens set. Therefore, the zoom lens system, the telephoto lens system, and the reverse telephoto lens system can all be functionally integrated into one system. The result is a very wide tuning range of FOV in addition to a high zoom ratio. (Zhang, Justis, and Lo 2005)

The goal of the later stages of the program was to demonstrate the lens technology in a real system. To do so required the entire experimental setup to be fabricated in a space comparable to the lenses. The resulting system weighed about 100 g, compared to 2 kg for a glass zoom lens of comparable performance. An interesting development from this phase of the program was a new approach to anti-reflective surfaces (Hiller, Mendelshon, and Rubner 2002; Wu et al. 2006). As an alternative to the conventional anti-reflective coating used for solid lenses, the MIT researchers developed an anti-reflective coating for flexible substrates based on silica nanoparticles. This development

involved an ambient temperature solution treatment to the surface using a layer-by-layer technique that has been well documented in the literature (Decher 1997; Mendelsohn et al. 2000). This lens system was demonstrated in a Pointer unmanned aerial vehicle (UAV) made by AeroVironment. The lens system demonstrated 20–30x zoom with a 2–60° FOV on a breadboard setup. The flight test demonstrated 30x at 2–60° FOV; however, demonstrated clarity was relatively poor.

## 2. Foveated Imaging

Our peripheral vision is optimized to survey a wide FOV and to see large objects. The part of the retina in the center of our gaze, called the fovea (see Figure 2-4), allows us to focus on highly detailed objects to perform tasks such as reading. Modern imaging and surveillance systems typically trade off FOV against resolution. A vision system inspired by this biological feature might allow for an efficient system that is capable of monitoring a small FOV at high resolution while monitoring a broad FOV at a resolution low enough to be processed quickly. (Hecht 2005)

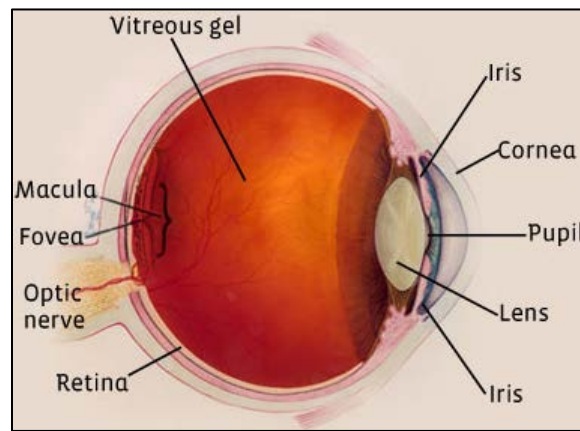

Source: Michigan Eye Bank (2010).

**Figure 2-4. The Human Eye**

**Note for Figure 2-4:** The fovea is the centermost part of the macula. This tiny area is responsible for our central, sharpest vision. Unlike the peripheral retina, it has no blood vessels. Instead, it has a very high concentration of cones (photoreceptors responsible for color vision), allowing us to appreciate color.

A team of researchers from the University of Central Florida (Orlando, Florida), Sandia National Laboratories (Albuquerque, New Mexico), the Air Force Research Laboratory (AFRL) (Kirtland, New Mexico), Boulder Nonlinear Systems (Lafayette, Colorado), and Narrascape (Albuquerque, New Mexico) studied optical foveated imaging using transmissive liquid crystal (LC) spatial light modulators (SLMs). The LC SLM is constructed by using birefringent nematic LC material to fill the space between two pixelated transparent electrodes. The LC SLM acts as a dynamically configurable wavefront controller. The optical path of the wavefront at each pixel on the SLM can be controlled

by locally changing the refractive index of the LC by applying a small voltage across the LC at each pixel. This process corrects aberrations in the system due to the wide FOV lens design. A transmissive SLM (see Figure 2-5) allows the optical foveated imaging system to be simpler, smaller, and more lightweight as opposed to systems based on a reflective SLM (Curatu, Wick, et al. 2005; Curatu 2009).

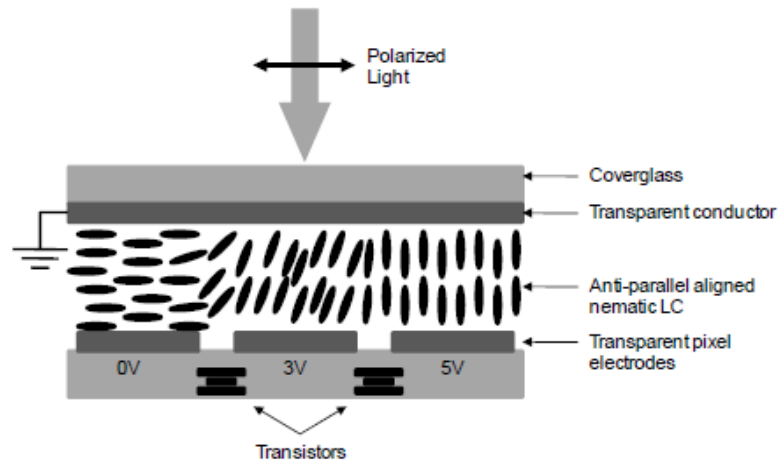

Source: Curatu (2009), 42.

**Figure 2-5. Transmissive LC SLM**

The team developed a transmissive SLM filled with high birefringence material ( $\Delta n = 0.38$ ) with  $1280 \times 1024$  resolution and a  $15\text{-}\mu\text{m}$  square pixel pitch. This technology was integrated into a wide FOV ( $\pm 60^\circ$ ) foveated imaging system (see Figure 2-6), and its demonstration provided the first attempt to use a transmissive LC SLM for this application (Harriman et al. 2006).

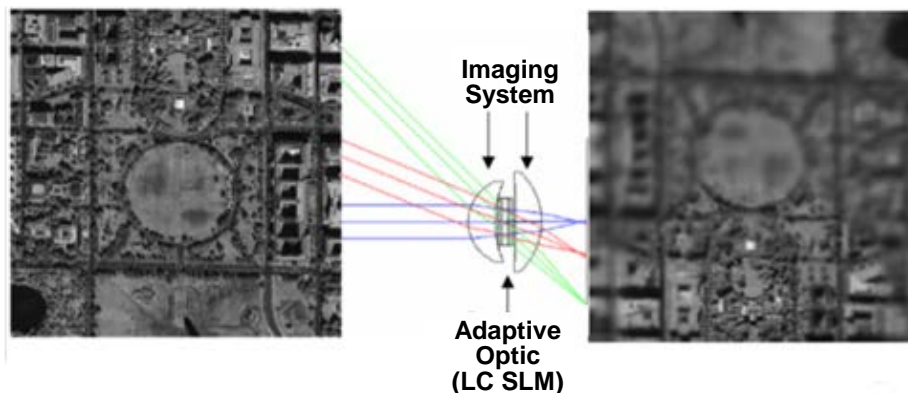

Source: Harriman et al. (2006), 61350C-11.

**Figure 2-6. Model of Wide FOV Foveated Imaging System with  $\pm 60^\circ$  FOV**

### 3. Photon Sieves

A brittlestar species, *Ophiocoma wendtii*, has an exoskeleton composed of calcite crystals that form an array of spherical microstructures that have a characteristic double-lens design. These diffractive microlenses focus light on receptors inside the tissue, essentially acting as one large compound eye. The design of the lens array minimizes spherical aberration and birefringence and allows the detection of light from a particular direction (Aizenberg et al. 2001, 821).

This design inspired work at the University of Florida (Gainesville) to develop the first photon sieves capable of focusing multiple visible and longer wavelengths of light. A photon sieve is a diffractive lens with an array of tiny holes arranged in a pattern similar to the rings in a Fresnel zone plate (see Figure 2-7). Light diffracting through each of the tiny holes constructively interferes at a focal point. The photon sieves were patterned on opaque silver films on a glass substrate using electron-beam lithography. The size and spacing of the pinholes were designed to focus two wavelengths of light (Chung et al. 2008). The subwavelength sizes of the pinholes, however, significantly reduce the amount of light that can be transmitted through the sieve. The transmission can be increased using a physical phenomenon that occurs when light strikes a metal surface. The free electrons of the metal respond by oscillating in resonance with the light waves and forming surface plasmons, which can help to concentrate and channel light. In this application, the surface plasmons can increase transmission through the sieve by channeling light hitting the opaque part of the structure. If the metal is structured properly, the plasmons can be converted back into light. (Barnes, Dereux, and Ebbesen 2003).

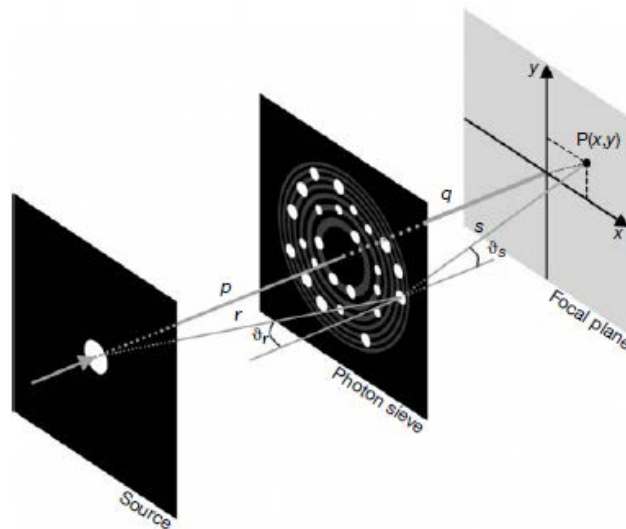

Source: Kipp et al. (2001), 185.

Figure 2-7. Imaging through a Photon Sieve



The photon sieve provides a much smaller and lighter lens than a conventional refractive lens. Since it is constructed on a flat chip, a 180° FOV lens with no moving parts is possible. In collaboration with the International Technology Center (ITC) (Raleigh, North Carolina) and Raytheon, a prototype mid-range munition seeker incorporating a dual wavelength (near infrared (NIR) and long wave infrared (LWIR)) photon sieve was designed. This system reduced the weight of the typical gimbaled system by two thirds and cut the volume in half.

#### 4. Nanolayer Lenses

Human eyes are made up of about 22,000 layers, each of which has a slightly different refractive index. The net effect of the layers is a smooth GRIN, which helps to focus light. The refractive index range ( $\Delta n$ ) of the human eye lens is about 0.03. Since water has a higher refractive index than air, aquatic animals need stronger lenses. The octopus eye, for example, has a spherical GRIN lens that provides five times stronger focus than a human eye, compensates for spherical aberration, and provides a wide FOV. The optical power of the octopus lens is derived from the high value of  $\Delta n$ , about 0.15 (Jagger and Sands 1999).

Case Western Reserve University (CWRU) (Cleveland, Ohio) and the Naval Research Laboratory (NRL) (Washington, DC) collaborated to create a synthetic lens that would mimic the structure and capabilities of this octopus eye. They formed their GRIN lenses from films that consisted of thousands of nanolayers of two different polymers having two different refractive indices (see Figure 2-8). The ratio of the two polymers was varied to produce films of a tailored refractive index. The films of various “n” were stacked to create a  $\Delta n$  and formed into hemispheres, which were combined to form the synthetic bi-convex octopus lens.

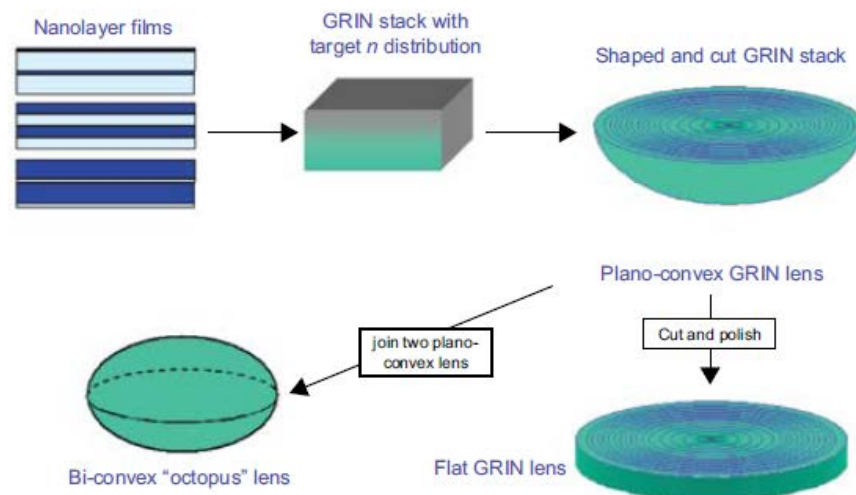

Source: Shirk et al. (2006), 57.

**Figure 2-8. Fabrication of Polymer GRIN Lenses**

Under the BOSS program, these GRIN lenses were used to explore reductions in the complexity and weight of multi-element imaging devices. Small UAVs have stringent space and weight limits that make the use of existing optical zoom technology a challenge. The CWRU/NRL team designed and constructed a zoom lens system consisting of three GRIN lenses for a short wave infrared (SWIR) sensor array to be flown on a small UAV (see Figure 2-9). This system demonstrated a 3.4x GRIN zoom (see Figure 2-10a) aboard the NRL-developed Dragon Eye UAV and provided easy identification of targets of interest (see Figure 2-10b).

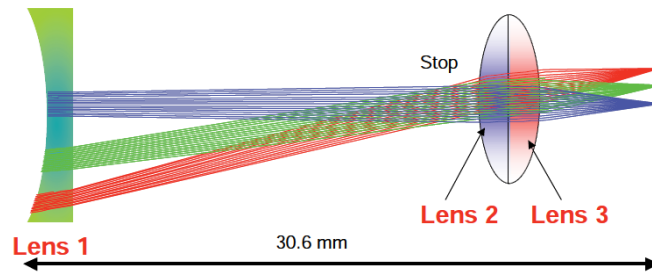

Source: Shirk et al. (2006), 60.

**Figure 2-9. Camera Lens System Composed of Three GRIN Lenses Demonstrated Aboard the Dragon Eye UAV**

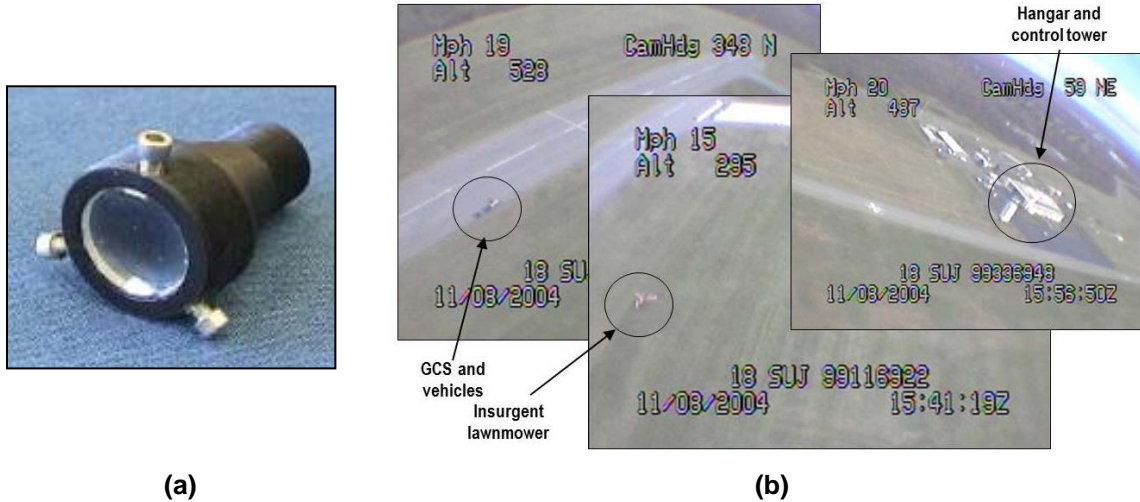

Source: Institute for Defense Analyses (2013).

**Figure 2-10. (a) 3.4x GRIN Zoom Used Aboard Dragon Eye UAV; (b) Results from Flight Test of GRIN Zoom Lens System at Aberdeen Proving Ground, Maryland**

This new class of GRIN lenses, their fabrication process, along with new design tools and metrology, will be the focus of the remainder of this document.

### 3. GRIN Lenses

---

Among the demonstrations of biologically inspired optical systems under the BOSS program, DARPA continues to be interested in the nanolayer GRIN lens technology. The design advantages of GRIN lenses have long been described in the literature; however, limited manufacturing capabilities have hindered the practical application of these lenses. In the M-GRIN program, DARPA aims to address these manufacturing issues and turn GRIN lenses into a realizable, low-cost solution for military optical system design.

Traditional lenses have a homogeneous refractive index throughout the material. The abrupt change between the refractive index of air and the lens causes light rays to be bent at the surface of the lens (see Figure 3-1(a)). Snell's law describes the amount of bending for these lenses. It states that the ratio of the sines of the angles of incidence and refraction is equivalent ratio of the phase velocities in the two media or equivalent to the reciprocal of the ratio of the indices of refraction. GRIN materials have a gradient refractive index within the material, causing light rays to be bent within the material (see Figure 3-1(b)).

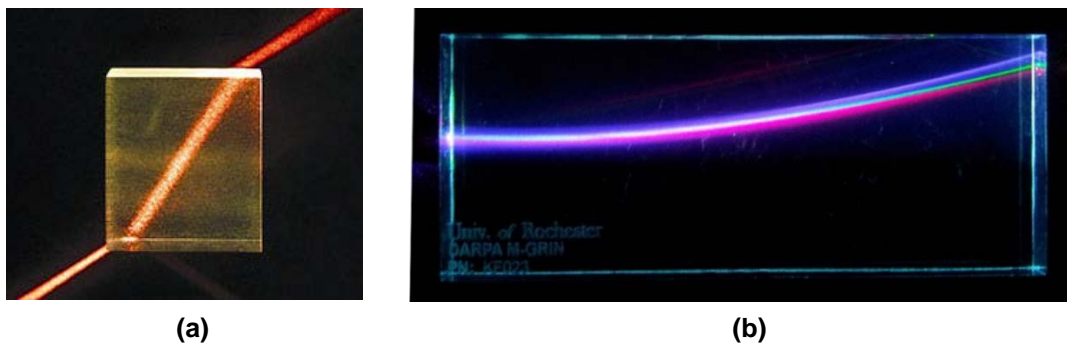

Source: (a) Kimera LLC (2013); (b) Courtesy of the University of Rochester.

**Figure 3-1. (a) Refraction through a Homogeneous Glass Slab;  
(b) Refraction through a GRIN Material**

Examples of GRIN media appear frequently in nature. While air temperature increases with greater proximity to a hot surface, the density of the air decreases and, therefore, the refractive index decreases. The air in this region acts as a GRIN medium and bends the light as it travels through, which results in the phenomenon of a mirage—a familiar example being the image of a wet road on a hot sunny day (see Figure 3-2). Similarly, the Earth's atmosphere acts as one huge GRIN lens since air density and

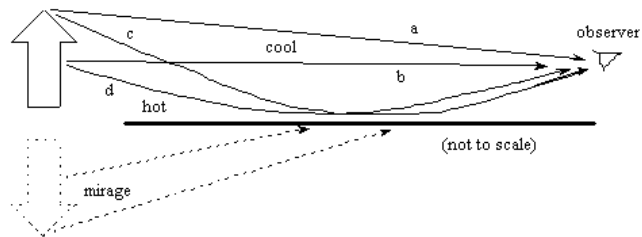

Sources Warren Wilson College (2007); Harvard Natural Sciences Lecture Demonstrations (n.d.).

**Figure 3-2. Mirage**

refractive index decrease with altitude. The resultant bending of light allows observers to see the sun for a few minutes after it has set and to see the stars while they are below the horizon. (Tsioulia 2003)

As discussed in the previous chapter, the optics of our own eyes and the other eyes of the animal kingdom have evolved to incorporate GRIN materials to provide stronger optical power and larger FOVs while correcting for spherical and chromatic aberration. The GRIN structure is a result of the layering of cells to form the biological lenses.

GRIN components have been applied to imaging and non-imaging applications. The GRIN media that make up these components typically have one of three basic types of refractive index gradients: axial, radial, or spherical. More complex GRIN media may involve a mixture of these distributions.

In axial gradient materials, the refractive index varies in the direction of the optical axis. Lenses constructed with an axial GRIN are useful in replacing aspherical surfaces to correct aberrations. Any aspherical lens can be replaced with an axial gradient lens and result in the same performance (Moore 2010).

Radial—or cylindrical—GRIN media have a refractive index profile that varies outward from the optical axis so that surfaces of constant index are concentric cylinders. The most common type of GRIN lens is a radial gradient lens with a quadratic refractive index distribution<sup>2</sup> described as

$$n(r) = n_o \left( 1 - \frac{Ar^2}{2} \right),$$

<sup>2</sup> Ray bending in a GRIN lens is proportional to the refractive index gradient. A quadratic profile, which has a linear gradient, will result in ray deflection varying linearly with the radius as required by the paraxial focusing condition.

where  $r$  is the distance from the optical axis,  $n_o$  is the axial refractive index, and  $A$  is a constant (Flores-Arias et al. 2006).

In 1905, R.W. Wood used a dipping technique to create a gelatin cylinder with a refractive gradient that varied symmetrically with the radial distance from the axis. Despite having flat faces, disk-shaped slices of the cylinder acted like converging or diverging lenses depending on whether the refractive index was decreasing or increasing relative to the radial distance (Wood 1905) (see Figure 3-3(a)). A non-imaging example of a radial gradient application is the gradient index fiber used for telecommunications. This fiber may be many kilometers long, with a diameter of ~20 to 100  $\mu\text{m}$ , and have a refractive index that is highest along the center. The gradient profile is chosen so that light rays follow a sinusoidal path down the fiber. See Figure 3-3(b).

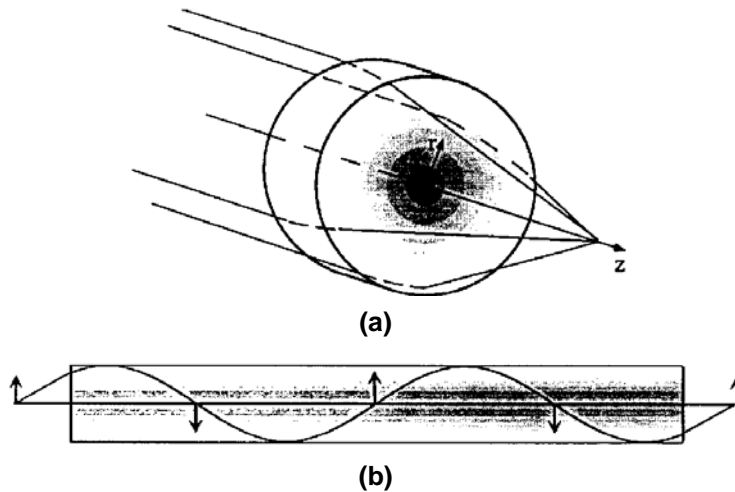

Source: Moore (2010)

**Figure 3-3. (a) Wood Lens; (b) Gradient Index Fiber**

GRIN materials with a spherical gradient have a refractive index that is symmetric about a point so that surfaces of constant index are concentric spheres. The refractive index gradient can be arbitrarily varied. However, certain gradients produce particularly interesting results. The classic example of a spherically symmetric lens was described by James Clerk Maxwell in 1854. This Maxwell fisheye lens (see Figure 3-4(a)) has a refractive index that varies according to

$$n(r) = \frac{n_o}{1 + \left(\frac{r}{R}\right)^2}.$$

A point source located on the spherical surface of radius  $R$  will be focused to the opposite point on the same surface. The paths of light rays through this lens are arcs of circles (Maxwell 1965). Almost a century later, Rudolf Luneburg (Luneburg 1944) described a

special case of this lens where the refractive index falls from  $\sqrt{2}$  at the center of the lens to 1 at its surface according to

$$n(r) = \sqrt{2 - \left(\frac{r}{R}\right)^2}.$$

The Luneburg lens (see Figure 3-4(b)) focuses parallel rays on the spherical surface onto a point on the opposite side of the lens. Luneburg lenses have been primarily applied as high-gain radio antennas.

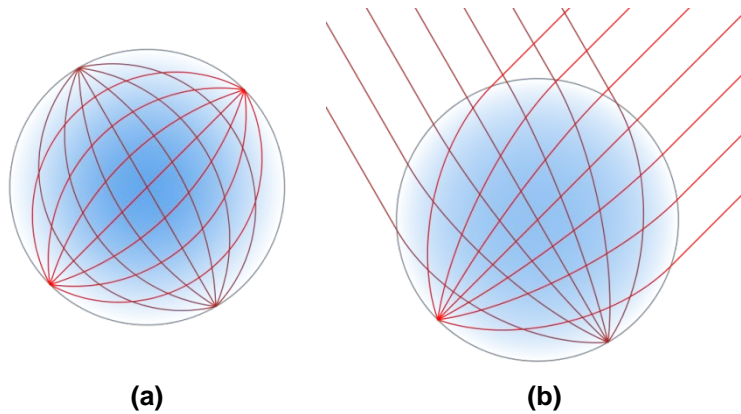

Source: (a) Wikimedia Commons (2013c); (b) Wikimedia Commons(2013b).

**Figure 3-4. (a) Maxwell's Fisheye Lens; (b) Luneburg Lens**

**Note for Figure 3-4:** Blue shading represents increasing refractive index.

Combining the effect of GRIN material with the geometric power obtained from curved surfaces offers elegant lens design possibilities. Researchers could design an optical system that provides high focusing power and wide FOV and corrects for aberrations—and does so with a reduced lens thickness and curvature and a reduced number of elements compared to traditional optical systems. Despite this potential, limited fabrication capabilities have prevented GRIN lenses from achieving widespread use.

## 4. Manufacturable Gradient Index Optics (M-GRIN) Lenses

---

In 2008, the DARPA Strategic Technology Office (STO) initiated the M-GRIN program (ongoing at publication time) to develop low-cost, customizable GRIN-based optics for use in a variety of military systems. Lenses dominate the weight and cost considerations of many optical systems and force tradeoffs between focal length, FOV, resolution, and range. The primary goal of the M-GRIN program was to address the GRIN lens manufacturing issues that would provide a potential solution to these issues. The program consisted of three approaches that included

- The design and reproducible fabrication of GRIN lenses for imaging and light collection;
- The integration of design, fabrication, and manufacturing methods; and
- The demonstration of a manufacturing capability to produce on-demand custom GRIN optics.

This effort included a significant focus on metrology, where new tools were required for monitoring the polymer nanolayer process for GRIN optics.

A key insight of this program was the idea that lenses can be used for applications beyond imaging. For example, in light collection, a GRIN lens may be superior to conventional optics, such as a solar concentrator with a larger acceptance angle. In laser applications, GRIN optics can provide higher conversion efficiency, improved positional tolerance, and more accurate beam shapes (Leger 2012).

The material systems and processes used by the M-GRIN performers were, at best, previously achieved at laboratory scale with one-at-a-time prototypes. In many cases, only proof of principle had been achieved. Often, many samples would be prepared to select the few samples that were suitable for the next step in a process. The program emphasized Manufacturing Readiness Levels (MRLs) as goals. An MRL 8 was proposed as a challenging (“DARPA-like”) goal. This level required the critical manufacturing processes to demonstrate acceptable yield for pilot line or low rate initial production (LRIP).

### A. GRIN Fabrication Techniques

Several manufacturing methods were reported in the scientific literature before the inception of the M-GRIN program. One widely used technique is to create a GRIN in a glass ion exchange process (Hensler 1975). Here, a homogeneous glass containing a

single valence ion, such as sodium, is submerged into a bath of molten salt containing a different ion, such as lithium bromide. Ions from the salt bath diffuse into the glass and replace the ions in the glass, creating a gradient in composition that results in a gradient in refractive index. The diffusion can be controlled by applying an electric field during the process or by changing the temperature. Linear, Gaussian, or Lorentzian gradient profiles can be created with this technique. The main limitations of ion exchange are that the GRIN can be created only over small geometries, ~10 mm, and the  $\Delta n$  produced is often quite small.

Other techniques include the following:

- **Neutron irradiation.** Boron-rich glass irradiated with neutrons where the neutron capture process in B-10 produces a change in the glass composition and thus a change in index of refraction (Sinai 1971).
- **Chemical vapor deposition (CVD).** Deposit layers of different glass (~2 cm) on a tube and then draw the tube so the thickness of each layer is less than the light wavelength in order to reduce scattering effects (Keck and Olshansky 1975).
- **Polymerization.** Monomer of organic material differentially changed to a polymer by irradiation with ultraviolet (UV) light or by laser beams (Moore 1973).
- **Ion stuffing.** Special glass is used. This glass, when heated, phase separates. One phase is soluble in acid and dissolves out, leaving a glass sponge. The glass is then exposed to a bath that fills the sponge with molecules, creating a gradient of index of refraction (Mohr et al. 1979).
- **Crystal growing.** From a silver-chloride/sodium-chloride bath, starting with a sodium chloride seed, a crystal is pulled that begins to deplete the sodium in the bath and starts to pull silver, forming a gradient (Houde-Walter and Moore 1986).
- **Sol-Gel.** Refractive-index modifying dopants diffuse through a porous gel, which is then dried and sintered into a GRIN glass (Zheng 1995).
- **Droplet on demand.** Applying ink-jet printer technology to GRIN lens manufacturing (Troost et al. 2001).
- **Multi-layer coextrusion.** Polymer processing technology that produces films with thousands of layers and layer thicknesses down to the nanoscale (Baer, Hiltner, and Shirk 2006). This process is discussed in detail in the following section.



## **B. GRIN Lens Fabrication Research in the DARPA BOSS Program**

The collaboration between CWRU and NRL under the DARPA BOSS program (see Chapter 2, Section B.4) spawned a technique to form a GRIN in polymers. Their approach produced GRIN lenses from films that consisted of thousands of nanolayers of two different polymers having two different refractive indices (Baer, Hiltner, and Shirk 2006). The key technology used to fabricate such films is a microlayer polymer coextrusion process, which appeared in the literature as early as 1969 (Alfrey, Gurnee, and Schrenk 1969; Schrenk and Alfrey 1969). This polymer processing technology was developed further at CWRU, and the application to the fabrication of GRIN lenses was patented (Baer, Hiltner, and Shirk 2006).

### **1. Forced Assembly Nanolayer Coextrusion**

The first step in the GRIN lens fabrication process is to create transparent nanolayered polymer films with a specific refractive index. Two polymers with substantially different refractive indices are chosen for layering. When the layer thickness and thus the modulation period of the index are less than one quarter of the wavelength of light ( $\lambda/4$ ), the films are transparent and have a refractive index of the effective composite medium. The bulk film refractive index is approximately the volumetric average of the component polymers, and it varies linearly with the relative layer thickness so that the film can be made with a refractive index anywhere between that of the components (Shirk et al. 2006).

The polymer films are produced via forced assembly multi-layer coextrusion processing. The two component coextrusion system consists of two single screw extruders with melt pumps that supply polymer A and polymer B to a coextrusion feed block (see Figure 4-1). To maximize layer uniformity and the overall quality of the film, the polymers are extruded at a temperature at which their viscosities match. The speed of the melt pumps can be adjusted to vary the ratio of A to B, thereby defining the bulk film refractive index. The feed block combines the polymers into layers that are then fed through a series of layer-multiplying die elements. Each die doubles the number of layers by first slicing the structure vertically, then spreading the melt horizontally, and finally stacking the two spread melts. A series of  $n$  multiplying elements produces a film of  $2^{(n+1)}$  alternating layers. Up to 11 dies have been used in this manner to produce films with 4,096 layers with individual layer thicknesses of less than 10 nm (Ponting, Hiltner, and Baer 2010). A coextrusion system described later (Ji et al. 2013) formed a three layer stack in the feed block resulting in  $2^{(n+1)} + 1$  alternating layers after passing through  $n$  multiplying elements.

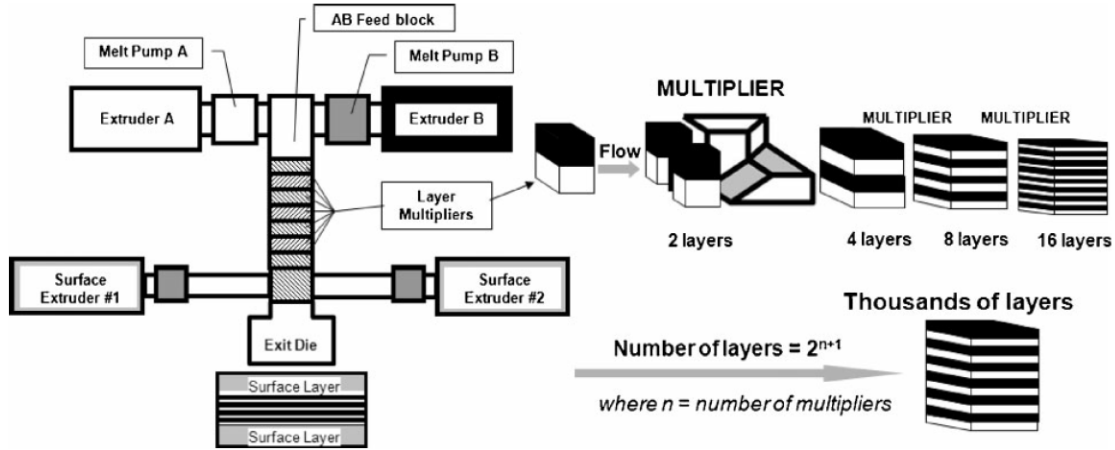

Source: Ponting, Hiltner, and Baer (2010), 20.

**Figure 4-1. Two-Component Coextrusion System (Left);  
Details of Layer Multiplication (Right)**

## 2. GRIN Lens Construction

Using the process just described, the CWRU team created a series of films by layering polymethyl-methacrylate (PMMA;  $n = 1.49$ ) with a styrene-acrylonitrile (SAN) copolymer with 17% acrylonitrile content (SAN17;  $n = 1.57$ ). A series of films with tailored refractive indices between 1.49 and 1.57 was produced by varying the relative thickness of the layers of PMMA to SAN17. The observed index of each 4,097-layer film varied linearly with the relative layer thickness. See Figure 4-2.

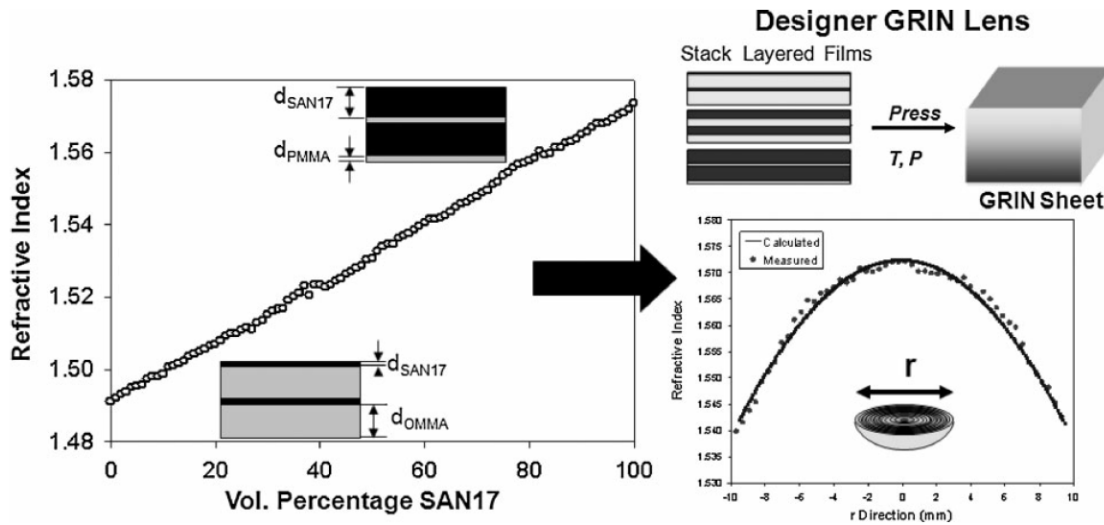

Source: Ponting, Hiltner, and Baer (2010), 28.

**Figure 4-2. Effect of Composition on Composite SAN17/PMMA Film Refractive Index**

A thick polymer sheet with a desired refractive index gradient was made by stacking 70–100 nanolayered films of varying indices and then compressing the stack with heat

(see Figure 4-3). The GRIN sheet was then thermoformed between a concave-convex mold pair into a spherical meniscus shape. After molding, the material was diamond polished to form a plano-convex lens with a spherically symmetric profile. In this same manner, GRIN lenses of a variety of different curvatures can be formed with radii from 3 mm to 60 mm.

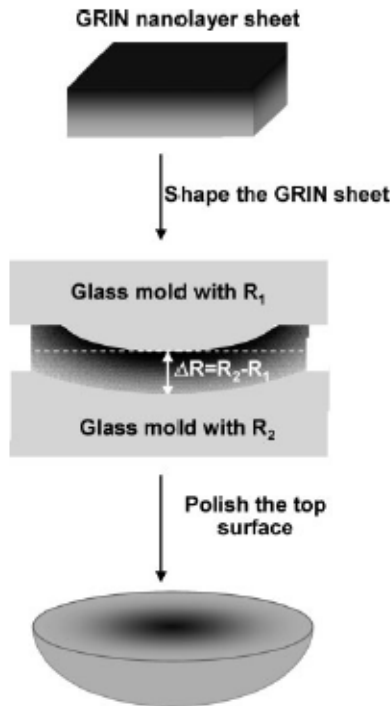

Source: Jin et al.( 2006), 1836.

**Figure 4-3. Process of Forming a GRIN Lens from a Stack of Nanolayer Films**

### C. Considerations Related to the Manufacturing Process

Each performer has several manufacturing thrusts within M-GRIN. The first is process development. All of the performers in the main M-GRIN effort generate axial gradients and then mold and/or assemble these gradients to form other GRIN structures (seedling efforts under M-GRIN explored other manufacturing paradigms). Thus, the manufacturing process is divided into base-material development, axial GRIN development, molding, and external shaping (cutting/grinding). The molding operation receives a lot of attention because it differs in a fundamental way from traditional molding operations. While most molding operations are intended to change the external shape of a block of homogeneous material, to mold an axial GRIN into a different target GRIN, the molding operation must preserve or dictate the configuration *internal* to the molded material.

Process maturation is another major focus: developing quality control procedures, understanding variation and tolerances, reducing variation, and standardizing procedures. The performers also worked on material development: trying to adjust the polymer chemistry leading to the GRIN, smoothing gradients, and adding material options to extend the  $\Delta n$  (refractive index range) achievable.

Material characterization and metrology are other focus areas. Manufacturing requires measurement of the index profiles to evaluate parts and processes. Moving from proof-of-principle systems to more mature systems for operational use, the performers needed to gather data on environmental stability to understand how temperature and humidity would affect optical performance. Measurements of coefficients of thermal expansion and moisture swelling are not unique to optical materials, but the performers also needed to establish the temperature influence on index of refraction and dispersion  $\frac{\partial n(\lambda)}{\partial T}$ , the effect of humidity on refractive index, and the effects of temperature and humidity on transmission, clarity, and so forth. The complexity involved in taking all of these measurements is compounded in the GRIN world by the material variability. Because the material composition varies smoothly over a range, each measurement must be taken at several compositions to characterize the full material set adequately.

In addition to material characterization, determining the quality of the product during and after production is important; thus, a large effort was expended in metrology related to manufacturing and quality control on lens blanks and finished elements. Given the material properties of a classical homogeneous lens, the surface geometry dictates the optical performance. Because the performance of a GRIN element is also governed by the internal GRIN geometry, the classical techniques are inadequate. In much the same vein as the unique molding challenges, machining of the outer surface of a GRIN lens requires the precise alignment and location of the internal gradient structure. Quality control requires a determination that the manufactured gradient is as designed. Both of these processes require non-destructive evaluation (NDE) techniques. Process development and characterization may require more precise measurement but does allow destructive techniques, including the destruction of samples prepared for interferometric measurement. Measurement of internal qualities other than index, such as internal reflections at interfaces, scattering, and so forth are also needed. Finally, measurement techniques similar to those in conventional lens manufacturing are needed to determine surface quality and shape.

The final thrust of the program is design. Each performer developed and attempted to manufacture a series of exemplary designs intended to showcase the added capability of a GRIN lens and demonstrate the efficacy of the manufacturing process. In addition to the exemplars, the performers also developed design tools to aid in the future development and adoption of GRIN lenses. Lens designers in industry cannot typically design an optimal lens directly. They use computer design and optimization software such as

Code V and Zemax to optimize complicated objective functions broadly over large numbers of input variables, including the number, shape, and material of lenses. Thus, an effort within M-GRIN was focused on developing software for use with Code V and Zemax to allow the design and optimization of GRIN lenses within the admissible parameter space of the materials and manufacturing methods. For instance, a way had to be found to specify the shape of internal GRIN contours and the gradient in terms of a tractable number of variables over which the design codes could be optimized.

## **D. M-GRIN Performers**

### **1. University of Rochester (UR)**

The UR team was led by the UR Institute of Optics and included Optical Polymers International for manufacturing. The UR team worked on two manufacturing technologies in M-GRIN.

#### **a. Process development**

##### **1) Glass ion diffusion**

The ions present in glass affect its refractive index. A long-known method of GRIN manufacture is to exchange ions of one type in the base glass for ions of a different type. This exchange has been done by immersing a rod of the base glass in a bath that is rich in the alternate ion. Ion diffusion then creates a radial gradient in the rod. However, ion-diffusion techniques are limited in achievable lens diameter because the diffusion time scales as the square of the radius. Increasing by a factor of ten in radius requires a factor-of-one-hundred increase in diffusion time. In one of the few true radial GRIN (as opposed to molded axial GRIN) processes on which work was done in M-GRIN, the UR team developed a procedure for fabricating large-diameter radial GRIN lenses faster by reducing the diffusion time of ion exchange of  $\text{Na}^+$  for  $\text{Li}^+$  (see Figure 4-4).

Before this work, the diffusion time for small-diameter lenses was 1 year. By changing the composition of the glass, the diffusion temperature, and the composition of the salt bath, the UR team reduced the diffusion time to less than 4 weeks (Visconti and Bentley 2013, 112103-1). This new process was a major improvement of a popular technique for making GRIN lenses. This technique was judged sufficiently mature (with regard to transition opportunity) at the end of the first phase of M-GRIN, so it did not continue under DARPA funding in the second phase.

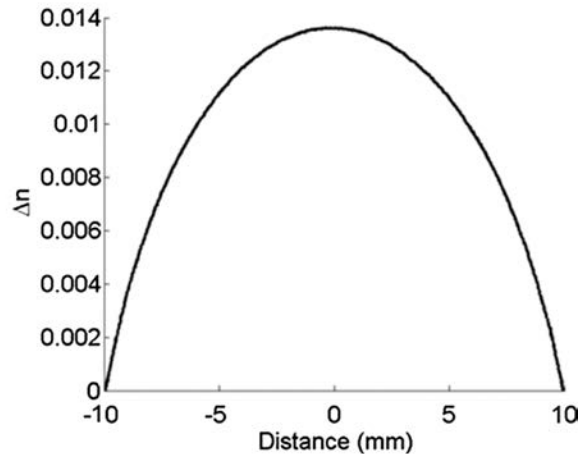

Source: Visconti and Bentley (2013), 112103-4

**Figure 4-4. Radial GRIN Profile from Enhanced Ion Exchange**

## 2) Monomer diffusion and copolymerization

In this method, the UR team created an axial refractive index gradient via a gradient in fractional composition of a polymethyl methacrylate/polystyrene (PMMA/PS) copolymer. This PMMA/PS copolymer was produced by diffusion of the methyl methacrylate and styrene monomers followed by polymerization. The resulting axial GRIN rods can be heated and molded to shape the gradient (Visconti et al. 2013). The remainder of the summary of the UR's work relates to the PMMA/PS copolymer GRIN process.

## 3) Radial GRIN

The UR team worked to develop a process for creating a polymer radial GRIN using a variant of its standard axial diffusion process.

### b. Process maturation

When M-GRIN started, the GRIN rods were being prepared in small batches or one at a time by graduate students. Under M-GRIN, the process control steps and variables (timing, chemistry, and temperature) were improved until the process could be transitioned to Optical Polymers International, a company that could semi-automate the process for larger batch manufacture, although still at small scale.

The UR team had problems with haze that formed in the GRIN rods and spent significant effort tuning the process variables until the haze was eventually eliminated.

### c. Metrology

As each GRIN rod was manufactured, the UR team needed to determine whether the gradient profile in the lens blank was appropriate (i.e., quality control). They worked on

metrology techniques to ascertain as-manufactured quality more rapidly. They also worked on a beam deflection technique that allowed a non-destructive estimation of the gradient in an axial GRIN, such as in the rods they were manufacturing. They built a test system using just a small laser on a translation stage and a camera (see Figure 4-5).

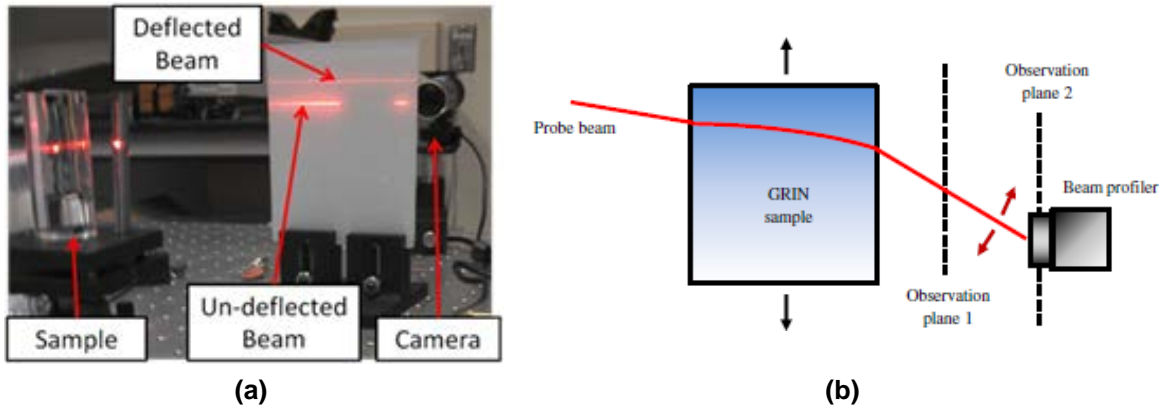

Source: (a) Courtesy of the University of Rochester; (b) Lin et al. (2013), 112108-4.

**Figure 4-5. GRIN Measurement by Deflectometry**

The Institute for Defense Analyses (IDA) extended this type of method to improve accuracy and developed similar methods using only angular beam deflection. The University of Minnesota, in collaboration with UR and IDA, developed an implementation of the angle-only method and analyzed the accuracy.

Previously, most index-of-refraction measurement techniques required a sample of homogeneous index. The UR team advanced interferometric techniques to measure very precisely the spatially varying index of refraction in a GRIN material and built the necessary interferometers. For instance, UR developed a multi-cavity Fabry-Perot interferometer for simultaneous measurement of thermal expansion and refractive index as a function of temperature (see Figure 4-6). In this device, the three optical path distances (OPDs) are used to disentangle three effects of temperature change as the temperature of the full system is varied in a thermal chamber.  $OPD_1$  reveals the change in cavity height,  $z$ .  $OPD_2$  (with  $OPD_1$ ) reveals the change in sample height  $L$  and, hence, the coefficient of thermal expansion.  $OPD_3$  reveals the change in refractive index given  $L$  and  $z$ . (McCarthy et al. 2012)

The UR team developed sufficient expertise in the measurement of GRIN that other performer teams used them as a subcontractor for metrology.

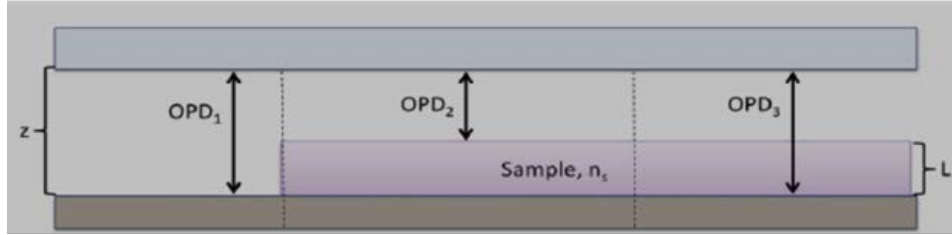

Source: McCarthy et al. (2012)

**Figure 4-6. Multi-Cavity Fabry-Perot interferometer**

#### **d. Design**

##### **1) Eye piece design**

In August 2013, UR published (Visconti et al. 2013) an eyepiece design using radial and spherical polymer GRIN optical elements and compared this design to a homogeneous lens system (see Figure 4-7). As shown in Figure 4-7, comparisons of single-element designs, two-element designs, and multiple-element designs show major improvements in aberration reduction and modulation transfer functions of GRIN systems over the homogeneous lens systems.

##### **2) Laser mode control**

Laser light formed in an optical cavity between two parallel mirrors is usually highly collimated (closely parallel to the optic axis), in addition to being coherent (can interfere spatially and temporarily). The divergence of high quality visible laser beams can be less than 1 mrad. However, laser diodes typically have a rectangular output aperture with a small length in one dimension and so they usually have large output divergences in that direction. Better collimation, useful in many applications, requires a collimating lens. A single GRIN lens can provide this higher collimation with a simpler design than a classical broad-band collimating lens (even for individually narrow-band lasers, a collimator may be used with a variety of wavelengths). UR designed and analyzed an axial GRIN singlet broadband laser collimator and showed favorable results relative to a homogeneous doublet (McCarthy and Moore 2013).

In a novel non-imaging application, Jim Leger at the University of Minnesota, first as a consultant to IDA and later as a subcontractor to UR, developed designs for GRIN-based mode control within a laser cavity and the computational tools to model them. These designs would change the resonant mode of the laser cavity with a GRIN insert without changing the size or shape of the cavity



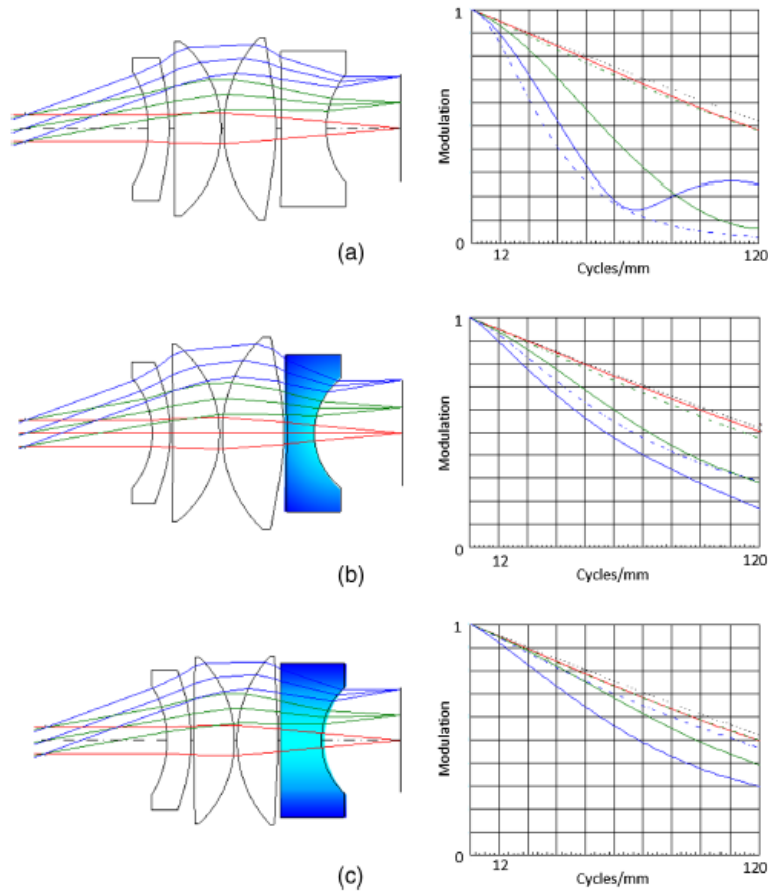

Source: Visconti, Corsetti, et al. (2013), 112102-5

**Figure 4-7. Multi-Element Comparison with Modulation Transfer Functions at 0°, 14°, and 20° Half FOV: (a) Homogeneous; (b) Spherical GRIN ( $\Delta n = 0.073$ );(c) Radial GRIN ( $\Delta n = 0.041$ )**

**Note for Figure 4-7:** Dashed lines indicate diffraction-limited performance.

### 3) Correcting thermal variations of GRIN

Plastic optical components are generally more sensitive to operating temperature than glass components. M-GRIN efforts sought ways to mitigate this sensitivity. The UR team extended earlier thesis work done at UR before M-GRIN—work that investigated the athermalization of polymer radial GRIN singlets by calculating the change in the index-of-refraction profile as a function of temperature change and the change in the curvature of the lens with the same temperature change. They identified optimum conditions when the change in one parameter counteracts the change in the other resulting in temperature insensitive optical performance.

## **2. Science Applications International Corporation (SAIC)**

The SAIC team included CWRU for material development, PolymerPlus, LLC for process development and manufacturing, NRL and UR for metrology, and Columbia University and Synopsis, Inc. for design.

### **a. Material development**

CWRU, extending the work done on the BOSS program, has continued to work on additional material systems with different polymers to extend the available refractive index range.

### **b. Process maturation**

An issue arose in the uncontrolled variability of feedstock, which was not under SAIC control. The polymer feedstock for the CWRU/PolymerPlus process contains polymer chains of the same composition but of varying lengths. The feedstock was sold on the basis of average molecular weight (reflecting polymer chain length) but without regard for the precise distribution of molecular weights. The feedstock supplier, without warning or notice, changed the feedstock. This change increased the diversity of molecular weight, but the average weight was unchanged. Suddenly, the chemistry was disrupted, and the optical quality of the nanolayer films was compromised; however, the SAIC team did not immediately know why. The team eventually discovered that the feedstock had been changed but, as a comparatively small user of the polymers, had no leverage on the supply chain. Eventually, the feedstock issue was resolved, but it required a lot of work to identify and remedy.

Optical coherence tomography (OCT), an imaging technique on which UR worked as a subcontractor to SAIC, revealed that distinct interfaces between nanolayers in the films were causing some light to reflect and thereby reducing the transmission of the material. Comingling some of the polymers together in each nanolayer—a process referred to as compatibilization—smoothed the interface between materials in each nanolayer. Switching from two-layer (AB) to three-layer (ABA) nanolayer building blocks eliminated intermaterial interfaces in the films when the nanolayer building blocks were consolidated and thereby improved the smoothness of interfaces. Together, these process adjustments significantly increased light transmission.

PolymerPlus took extensive measurements of the films that they produced to determine the location-to-location variability of thickness and refractive index within a film. This type of careful process variability characterization was central to the manufacturing maturity thrust of M-GRIN. In this case, film refractive index homogeneity was found to be less than desired. PolymerPlus discovered that premixing the polymer feedstock pellets increased the uniformity of index in the films.

### c. Metrology

UR (Institute of Optics, but distinct from the research group leading the UR team), extended OCT for use in GRIN NDE. OCT, a technique for obtaining subsurface images of translucent or opaque materials at a resolution better than 10  $\mu\text{m}$ , provides a tool for investigating GRIN irregularities during the manufacturing process. OCT has generated much interest in the medical community because it provides live subsurface images without preparation of the sample and does not use ionizing radiation. It has been used for non-destructive metrology of layered polymeric GRIN material (Meemon et al. 2013), including nanolayered spherical GRIN polymer optical elements (see Figure 4-8).

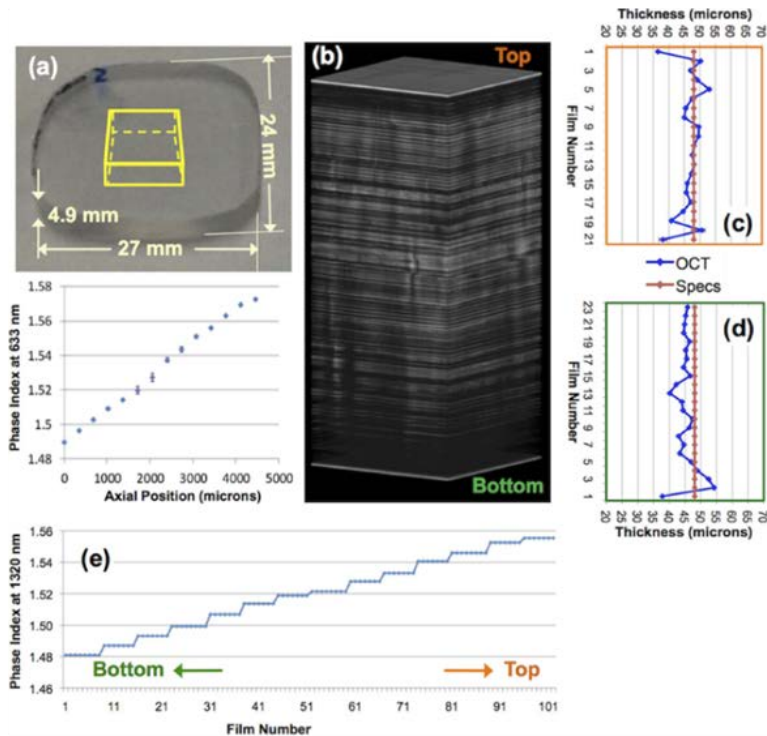

Source: Meemon et al. (2013), 6.

**Figure 4-8. OCT Imagery (a) of Nanolayer Films with Index and Thickness Indicated (c)–(e) and of a Consolidated Sheet (b)**

OCT was used to identify the distinct interfaces (later remedied) between nanolayers in the PolymerPlus films referred to previously. It was also used to characterize the thicknesses of the films after consolidation and the concentricity of the spherical surfaces after molding.

## d. Design

### 1) Monocentric lenses

Columbia University developed Luneburg-like spherical lens designs for imaging and for solar concentration constrained by the achievable index ranges of the CWRU/PolymerPlus process (see Figure 4-9). PolymerPlus manufactured a spherical demonstrator lens of multiple bonded hemispherical GRIN shells and a homogeneous core.

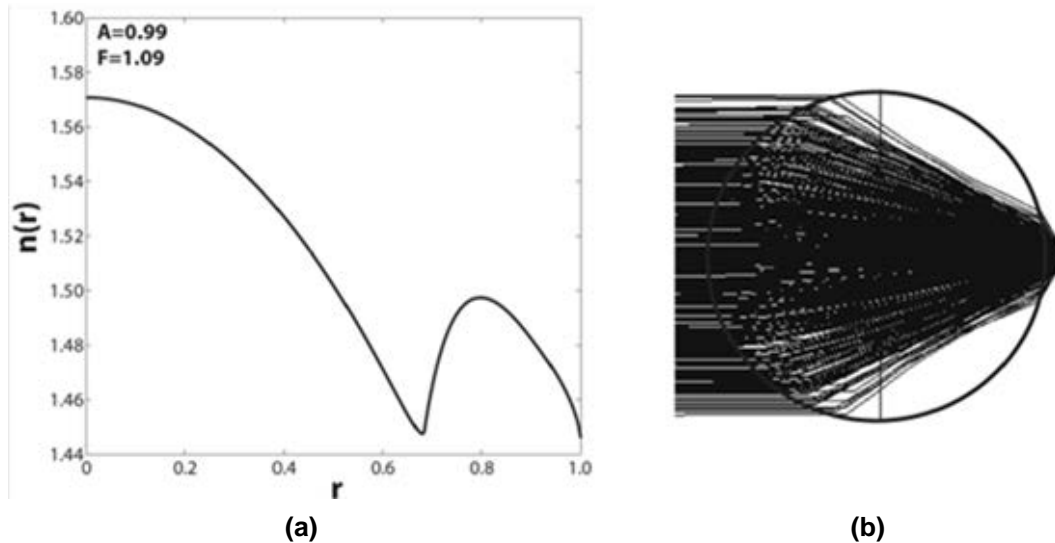

Source: Kostidas, Modi, and Gordon (2011), 15594.

**Figure 4-9. Columbia University Design for Ultra-High Efficiency Solar Concentrator: (a) Index Profile (b) Polychromatic Ray Trace**

### 2) Design tools

NRL developed a set of macros and dynamic-link libraries (DLLs) for the Zemax optical design code to characterize the materials and allow the use of the design optimizer for lenses constructed using the CWRU/PolymerPlus process. Optical Research Associates did the same for Code V. These tools are intended to be available publicly to enable potential customers to develop applications of the process.

### 3. Surmet Corporation

Surmet Corporation in Buffalo, New York, developed GRIN materials using Aluminum Oxy-Nitride (AlON), a ceramic material with broadband transparency (UV/Visible/mid-wave infrared (MWIR)). Surmet is known for building sensor windows and homogeneous lenses from AlON but had not previously explored making GRIN AlON.

### **1) Process development**

Surmet determined how to vary the composition of the AION to produce variations in refractive index. Layering base materials of various compositions (and therefore indices) allowed Surmet to produce smooth gradients by means of diffusion. It did a lot of work in creating the variation in index and controlling the diffusion for tailorable gradients to produce axial GRIN broad-spectrum lenses. It is also investigating methods of building radial GRIN lenses.

### **2) Metrology**

Surmet used UR as a subcontractor for metrology implementation since many of the methods had been developed or matured by UR.

## **4. Northrop Grumman Corporation (NG)**

The NG team included NRL for material development; IRFlex Corporation, Rochester Precision Optics (RPO), and The Ohio State University (OSU) for manufacturing; and Blu Optics, LLC for design. The NG effort began as a seedling effort and became a full-fledged program performer later than the other main-effort performers.

### **1) Material development**

NRL developed a series of about a dozen chalcogenide glasses with the index of refraction dependent on material mix and characterized the optical and physical properties of the glasses. It constrained its search for glasses to compositions with approximately the same glass transition temperature so that the glasses could be molded together. The chalcogenide glasses are broad spectrum infrared (IR) transparent, and the NRL/NG effort focused on multi-band IR glasses for applications in the SWIR to the MWIR.

No IR optical cement is useful for chalcogenide glasses because of their high index of refraction, so cemented doublets or triplets (two or three conforming lenses bonded together), which are a principal tool for controlling aberrations in the visible spectrum, have not been possible. The NRL glasses can be fused together (thermal expansion coefficients constrain which glasses can be adjacent) enabling n-tuple IR lenses (see Figure 4-10).

### **2) Process development**

The NG team investigated inter-glass diffusion for true GRIN (rather than n-tuple) lenses, but this investigation has not progressed much beyond measuring diffusion coefficients for a few cases. Nevertheless, the expansion of the chalcogenide glass library and the development of a family of IR lens materials amenable to the manufacture of doublets and triplets represent significant advances in optical manufacturing capability for the IR.

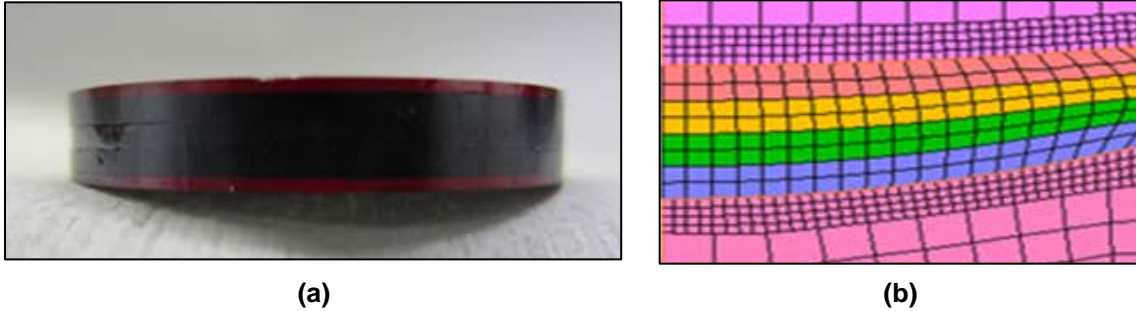

Source: Courtesy of Northrop Grumman

**Figure 4-10. (a) Fused Chalcogenide Stack; (b) Molding of Such a Preform into a Lens**

OSU worked on molding processes, trying to create concentric spherical interfaces from a layer-parallel stack of glasses with varying thermal and mechanical properties.

### 3) Design

NG took advantage of the broad-spectrum IR transmission of its materials to investigate applications that would allow a single optical path for multiple IR bands in systems that today require multiple independent optical paths with separate lens systems.

## 5. Seedling Efforts

The seedling efforts under the second phase of M-GRIN were attempts to create arbitrary three dimensional (3D) GRIN structures.

### a. Pennsylvania State University

The Penn State team includes Lockheed Martin Missiles and Fire Control for design and Clemson University/University of Central Florida for material development. They developed a set of independently useful MWIR to LWIR glasses with nano-ceramic crystals in which the crystal size and density determine the index of refraction. The team measured crystallization behavior under various temperatures and laser illumination conditions and learned how to control the crystal size and density. Thus, they effectively created a library of glasses with tailorable indices of refraction, achieving refractive index changes up to 0.25 in the MWIR. The University of Central Florida spun off a company, IRradiance Glass, Inc., to produce the glasses, whether for GRIN or homogeneous applications. For GRIN manufacture, the team proposed a process to “write” the index of refraction into the tailorable bulk material using laser-induced local crystallization. Penn State proposed the use of bulk GRIN material as lenses and the thin layers of a GRIN material coating homogeneous lenses to correct aberrations of an underlying homogeneous lens (see Figure 4-11).

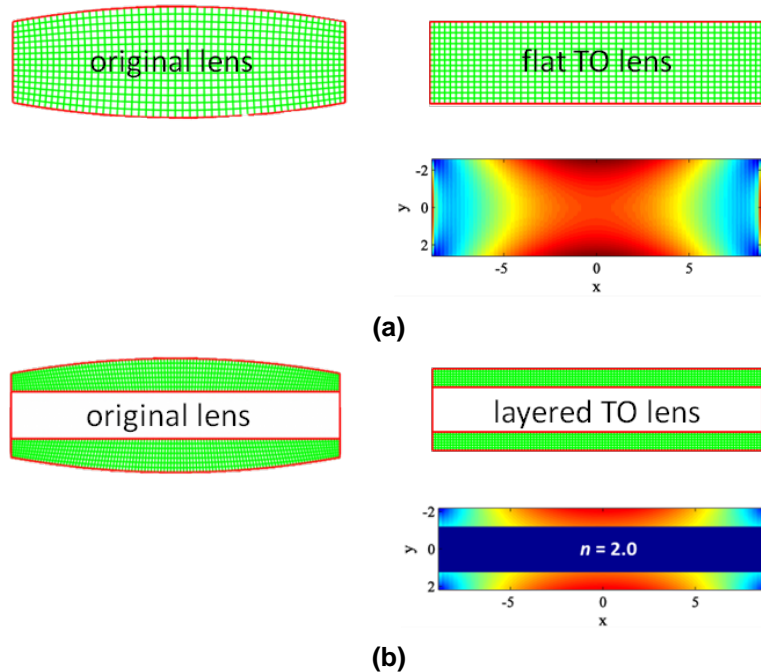

Source: Courtesy of Penn State University.

**Figure 4-11. Approaches to Lens Design and Manufacture Using TO:**  
**(a) Bulk GRIN Lens and (b) Thin GRIN Overlay of Bulk Homogeneous Lens**

Penn State’s design scheme aims to take advantage of transformation optics (TO), an analytical design technique that exploits a spatial transformation of Maxwell’s equations to map one optical geometry to another using an altered, non-uniform refractive index distribution (e.g., flat Luneburg lens). TO designs typically contain highly non-linear refractive index profiles, often preserving radial symmetry. The arbitrary 3D GRIN distribution produced with the laser-writing process would allow such TO designs to be implemented.

One pitfall of TO designs in general is that they require prescribed variation in both the permittivity and permeability of the material and sometimes require a low or negative index of refraction. However, the use of quasi-conformal TO instead of the general TO theory allowed the Penn State team to control, mitigate, or remove the undesirable magnetic, anisotropic, and zero/negative index properties of a given design. A custom suite of quasi-conformal mapping, optical analysis, and optimization software tools developed at Penn State were combined together (spun off into a company E x H, Inc.) and applied to the 3D-GRIN design problem to allow optical TO devices to be specified with constraints on the indices of refraction and the desired fabrication methodologies. Penn State achieved notable increases in optimization efficiency by applying the latest developments in global optimization algorithms.

### **b. Voxel, Inc.**

The Voxel team developed a set of GRIN “inks” for deposition with inkjet printer technology to construct an arbitrary 3D GRIN. Much of the Voxel effort has focused on developing the chemistry of the inks, which are liquid suspensions of nano-ceramic particles, where particle type and density determine index of refraction. The liquid ink is printed and subjected to a curing process to solidify it and lock in the gradient.

Voxel worked with candidate combinations of solvent matrices and nanoparticles to solve agglomeration challenges, ensure proper fluid dynamic properties for deposition, and maintain optical properties through the curing process. One of the biggest challenges was increasing the nanoparticle mass fraction of the inks to increase the available range of refractive indices.

Voxel successfully printed axial GRIN parts but has not yet printed functioning lenses.

### **c. Corporation for National Research Initiatives (CNRI) GRIN exchange**

CNRI operates the MEMS Exchange, a facilitator between customers and the various designers, consultants, additive manufacturers, and other participants in the MEMS manufacturing process. The CNRI team, led by Michael Huff, created the framework for a similar facilitator for GRIN lenses modeled off of their previous work on the MEMS Exchange. The idea was to ease the adoption of GRIN in small-scale applications by allowing potential customers to access designers or design consultants and then to mix and match manufacturing, measurement, and assembly processes from various M-GRIN performers. Potential GRIN users could implement small lot, on-demand production without developing an in-house capability. The MEMS Exchange would act as the trusted middleman for customers, protecting their intellectual property and privacy.

The GRIN Exchange set up the framework for databases where participants could characterize their materials, processes, and capabilities and also started a discussion forum where GRIN users could exchange advice and information. The mechanisms for signing up, consulting, selecting manufacturing products, and purchasing were imported from the MEMS Exchange. The GRIN Exchange was also in the process of setting up safeguards for export control and for in-house GRIN consulting (design and manufacturing). The GRIN Exchange was canceled because it was deemed premature relative to the manufacturing capabilities developed in M-GRIN and because there was not enough ability to mix and match between processes.



## **E. GRIN Lens Manufacturing Issues**

### **1. Environmental Stability of Plastic GRIN Lenses**

Glass lens' materials tend to have low coefficients of thermal expansion and small changes in refractive index with temperature relative to polymer lens' materials. Polymers, in contrast to glasses, can also absorb water from ambient humidity and swell. One of the biggest hurdles to the adoption of polymeric GRIN lenses for many stressing military and civilian applications is the lack of assurance that these lenses will function properly over the range of operational conditions. In some cases, a user can compensate for the first-order effects of moisture and temperature by adjusting the focal length of a system. Nevertheless, until environmentally driven changes in shape and optical properties of plastic GRIN lenses are more thoroughly understood, many user communities would not accept plastic GRIN replacements for homogeneous glass lenses regardless of the benefits under ideal conditions. As UR proposed, these effects might be mitigated using the GRIN degrees of freedom to design a lens in which the property changes cancel each other. Even if such an approach negated the additional optical benefits promised by GRIN optics, the weight savings from plastic optics as one-for-one replacements for glass optics might be worthwhile.

### **2. Residual Stresses from Molding**

After heating and press-forming, residual stresses can cause cracking or creep. This issue is one that many of the performers have faced and attempted to address through changes in processing times and conditions with regard to temperature and pressure ramping in the molding process.

### **3. Coatings**

Optical components perform best when anti-reflection coatings are applied to prevent light loss through the optical path. Many high-quality anti-reflection coatings are applied in high-temperature and high-vacuum processes when the substrate can withstand the elevated temperature. Solution and low-temperature vacuum deposition techniques can also be used for lower temperature substrates (Chen 2001; Uhlmann et al. 1997). Solution techniques such as sol-gel are preferable over vacuum techniques from an economic perspective due to the capital and maintenance costs. Sol-gel techniques cannot always be applied conformally and uniformly to curved substrates due to surface tension effects. These processes are not highly compatible with polymeric optical components that have surface curvature.

Coating polymer lenses with surface curvature for anti-reflection will require a room-temperature solution process that produces a conformal coating, with precise control of the coating thickness. One approach to this problem is an electrostatic

layer-by-layer assembly technique that was originally described by Decher (1997). This technique was a relatively simple process to deposit multilayers on a variety of surfaces using consecutive absorptions of polyanions and polycations. Shimomura et al. (2010) used this technique to assemble a broadband anti-reflection coating. In this work, nanoparticle thin films were deposited in a layer-by-layer process onto a soda lime glass substrate. The conformal coatings demonstrated 99.5% transmission over the entire visible range (440–800 nm). This process would be highly compatible with polymer nanolayer lenses that have surface curvature.

## **F. Looking Forward**

At the start of the program, some believed that the added degrees of freedom and associated advantages of GRIN optics would inspire applications as soon as the manufacturability of the lenses was within reach. In reality, all of the performers have struggled to demonstrate significant GRIN advantages in real applications or, conversely, to identify applications where M-GRIN products would have substantial advantages. This surprising disappointment led the government to convene an internal government “design team” to help identify promising designs or applications and to attempt to understand more broadly how to quantify the potential advantages of GRIN optics. DARPA has not yet achieved a complete understanding of the circumstances under which GRIN optics would show an advantage or what that advantage would be. Some progress has been made, including analysis of the conditions for singlet size and mass reduction using GRIN (Mait 2013).

At the time of publication, M-GRIN is planning for the following:

- The design team to set reasonable expectations for GRIN optical performance as a function of achievable index range and gradient magnitude, leading to an understanding of promising design space;
- The performers to identify and quantify specific advantages of GRIN designs vs. state-of-the-art homogeneous optic designs;
- The performers to show small-lot reliability and yield for the identified designs since the lens-blank production processes have matured;
- The performers to demonstrate proof of principle and then repeatability for molding and cutting the blanks into lenses that match the target optical properties; and
- The performers to demonstrate sufficient environmental stability for threshold optical performance, and, if this constrains the degrees of design freedom, the performers to show GRIN advantage under those constraints.

The M-GRIN program has significantly advanced the state of the art and has brought large-diameter GRIN lenses within reach for a broader set of optical system designs. Significant hurdles to wide-spread adoption remain, but the basis has been established for producing niche solutions today and evolving into broader use in the future.



# Illustrations

---

## Figures

Figure 1-1. The EM Spectrum .....	1-1
Figure 1-2: Examples of Ancient Mirrors: (a) Egyptian Silver/Copper Alloy, (b) Chinese Bronze, (c) Roman Glass .....	1-2
Figure 1-3. Ancient Lenses: (a) Layard/Nimrud Lens, (b) Viking Lens, (c) a Magnifying Lens or an Ornament .....	1-3
Figure 1-4. (a) Reading Stone Used to Magnify Print; (b) Spectacles Used to Read Manuscripts.....	1-4
Figure 1-5. (a) Camera Obscura; (b) Principle of a Pinhole Camera; (c) Image from a Modern Pinhole Camera Showing Infinite Depth of Field.....	1-4
Figure 1-6. Snell's Law.....	1-5
Figure 1-7. Eyepiece Designs: (a) Convex (Kepler), (b) Negative (Galileo), (c) Nagler .....	1-6
Figure 1-8. An Achromatic Doublet Formed from a Concave Flint Glass Element with High Dispersion and a Convex Crown Glass Element with Lower Dispersion .....	1-7
Figure 1-9. Ray Trajectory without (Green) and with (Red) Barlow Lens .....	1-7
Figure 2-1. Eight Types of Animal Eyes .....	2-1
Figure 2-2. Spherical Aberration (Left) and the Solution for It in the Fish Eye Crystalline Lens: Decreasing Refractive Index from the Center to the Surface.....	2-3
Figure 2-3. Fluidic Adaptive Lens of Transformable Lens Type .....	2-5
Figure 2-4. The Human Eye.....	2-6
Figure 2-5. Transmissive LC SLM .....	2-7
Figure 2-6. Model of Wide FOV Foveated Imaging System with $\pm 60^\circ$ FOV .....	2-7
Figure 2-7. Imaging through a Photon Sieve .....	2-8
Figure 2-8. Fabrication of Polymer GRIN Lens .....	2-9
Figure 2-9. Camera Lens System Composed of Three GRIN Lenses Demonstrated Aboard the Dragon Eye UAV.....	2-10
Figure 2-10. (a) 3.4X GRIN Zoom Used Aboard Dragon Eye UAV; (b) Results from Flight Test of GRIN Zoom Lens System at Aberdeen Proving Ground, Maryland.....	2-10
Figure 3-1. (a) Refraction through a Homogeneous Glass Slab; (b) Refraction through a GRIN Material.....	3-1
Figure 3-2. Mirage .....	3-2
Figure 3-3. (a) Wood Lens; (b) Gradient Index Fiber .....	3-3

Figure 3-4. (a) Maxwell’s Fisheye Lens; (b) Luneburg Lens .....	3-4
Figure 4-1. Two-Component Coextrusion System (Left); Details of Layer Multiplication (Right) .....	4-4
Figure 4-2. Effect of Composition on Composite SAN17/PMMA Film Refractive Index .....	4-4
Figure 4-3. Process of Forming a GRIN Lens from a Stack of Nanolayer Films .....	4-5
Figure 4-4. Radial GRIN Profile from Enhanced Ion Exchange .....	4-8
Figure 4-5. GRIN Measurement by Deflectometry .....	4-9
Figure 4-6. Multi-Cavity Fabry-Perot interferometer .....	4-10
Figure 4-7. Multi-Element Comparison with Modulation Transfer Functions at 0°, 14°, and 20° Half FOV: (a) Homogeneous; (b) Spherical GRIN ( $\Delta n = 0.073$ );(c) Radial GRIN ( $\Delta n = 0.041$ ).....	4-11
Figure 4-8. OCT Imagery (a) of Nanolayer Films with Index and Thickness Indicated (c)–(e) and of a Consolidated Sheet (b) .....	4-13
Figure 4-9. Columbia University Design for Ultra-High Efficiency Solar Concentrator: (a) Index Profile (b) Polychromatic Ray Trace .....	4-14
Figure 4-10. (a) Fused Chalcogenide Stack; (b) Molding of Such a Preform into a Lens.....	4-16
Figure 4-11. Approaches to Lens Design and Manufacture Using TO: (a) Bulk GRIN Lens and (b) Thin GRIN Overlay of Bulk Homogeneous Lens .....	4-17

## References

---

- Aizenberg, Joanna, Alexei Tkachenko, Steve Weiner, Lia Addadi, and Gordon Hendler. 2001. "Calcitic Microlenses as Part of the Photoreceptor System in Brittlestars." *Nature* 412 (August 23): 819–822. doi:[10.1038/35090573](https://doi.org/10.1038/35090573).
- Alfrey, T., E. F. Gurnee, and W. J. Schrenk. 1969. "Physical Optics of Iridescent Multilayered Plastic Films." *Polymer Engineering and Science* 9 (1) (November): 400–404. doi:[10.1002/pen.760090605](https://doi.org/10.1002/pen.760090605).
- Baer, E., P. A. Hiltner, and J. S. Shirk. 2006. "Multilayered Polymer Gradient Index (GRIN) Lenses." U.S. Patent 7,002,754 B2, filed September 16, 2004, and issued February 21, 2006.
- Barnes, William L., Alain Dereux, and Thomas W. Ebbesen. 2003. "Surface Plasmon Subwavelength Optics." *Nature* 424 (August): 824–830. doi:[10.1038/nature01937](https://doi.org/10.1038/nature01937).
- Brooklyn Museum Website. 2011. "Collections: Egyptian, Classical, Ancient Near Eastern Art: Mirror." Accessed October 5, 2013. <http://www.brooklynmuseum.org/opencollection/objects/4068/Mirror>.
- Chen, D. 2001. "Anti-reflection (AR) Coatings Made by Sol-Gel Processes: A Review." *Solar Energy Materials & Solar Cells* 68 (3–4) (June): 313–336. <http://www.sciencedirect.com/science/article/pii/S0927024800003652>.
- Chung, Hsiu-Hsin, Narada M. Bradman, Mark R. Davidson, and Paul H. Holloway. 2008. "Dual Wavelength Photon Sieves." *Optical Engineering* 47 (11) (November): 118001-1–118001-10. doi:[10.1117/1.3029672](https://doi.org/10.1117/1.3029672).
- Curatu, George. 2009. "Analysis and Design of Wide-Angle Foveated Optical Systems." PhD thesis, University of Central Florida. [http://etd.fcla.edu/CF/CFE0002584/Curatu\\_George\\_C\\_200905\\_PhD.pdf](http://etd.fcla.edu/CF/CFE0002584/Curatu_George_C_200905_PhD.pdf).
- Curatu, George, David V. Wick, Don M. Payne, Ty Martinez, Jamie Harriman, and James E. Harvey. 2005. "Wide Field-of-View Imaging System Using a Liquid Crystal Spatial Light Modulator." *Proceedings of SPIE* 5874 (August): 587408-1–587408-7. doi:[10.1117/12.619257](https://doi.org/10.1117/12.619257)
- DAWN Media Group. 2013. "Ancient Chinese Bronze Mirrors." Accessed October 5, 2013. <http://beta.dawn.com/news/672475/ancient-chinese-bronze-mirrors-the-lloyd-cotsen-collection>.
- Decher, Gero. 1997. "Fuzzy Nanoassemblies: Toward Layered Polymeric Multicomposites." *Science* 277 (5330) (August): 1232–1237. doi:[10.1126/science.277.5330.1232](https://doi.org/10.1126/science.277.5330.1232).

- Deep Ocean Diving. n.d. "Underwater Vision." Last modified on March 13, 2005. Accessed October 5, 2013. <http://www.deeptune.net/deeptune/index.php?science02.php>.
- Drewry, Richard D., Jr. 2007. "What Man Devised That He Might See." Accessed October 5, 2013. <http://www.teagleoptometry.com/history.htm>.
- Fishman, Ronald S. 2000. "Perish Then Publish: Thomas Harriot and the Sine Law of Refraction." *Archives of Ophthalmology* 118 (3) (March): 405–409. doi:[10.1001/archopht.118.3.405](https://doi.org/10.1001/archopht.118.3.405).
- Flores-Arias, M.T., C. Bao, A. Castelo, M.V. Perez, and C. Gomez-Reino. 2006. "Crossover Interconnects in Gradient-Index Planar Optics." *Optics Communications* 266 (2) (October): 490–494. <http://www.sciencedirect.com/science/article/pii/S0030401806005712>.
- Garner, L. F., G. Smith, S. Yao, and R. C. Augusteyn. 2001. "Gradient Refractive Index of the Crystalline Lens of the Black Oreo Dory (*Allocyttus Niger*): Comparison of Magnetic Resonance Imaging (MRI) and Laser Ray-Trace Methods." *Vision Research* 41 (8): 973–979. <http://www.sciencedirect.com/science/article/pii/S0042698901000116>.
- Harriman, Jamie, Sebastian Gauza, Shin-Tson Wu, David Wick, Brett Bagwell, Ty Martinez, Don Payne, and Steven Serati. 2006. "Transmissive Spatial Light Modulators with High Figure-of-Merit Liquid Crystals for Foveated Imaging Applications." *Proceedings of SPIE* 6135 (February): 61350C-1–61350C-13. doi:[10.1117/12.663470](https://doi.org/10.1117/12.663470).
- Harvard Natural Sciences Lecture Demonstrations. n.d. "Hot Road Mirage." Cambridge, MA: Harvard University, Lecture Demonstration Services. [http://isites.harvard.edu/icb/icb.do?keyword=k16940&pageid=icb.page93268&pageContentId=icb.pagecontent221621&view=view.do&viewParam\\_name=indepth.html#a\\_icb\\_pagecontent221621](http://isites.harvard.edu/icb/icb.do?keyword=k16940&pageid=icb.page93268&pageContentId=icb.pagecontent221621&view=view.do&viewParam_name=indepth.html#a_icb_pagecontent221621).
- Hecht, Jeff. 2005. "Lessons from Nature: Borrowing Ideas That Nature Incorporated into Biological Eyes Promises a New Generation of Optical Systems." *Laser Focus World* (January 1): 113–117. <http://www.laserfocusworld.com/articles/print/volume-41/issue-1/features/photonics-frontiers-biologically-inspired-optics/lessons-from-nature.html>.
- Hensler, J. R. 1975. "Method of Producing a Refractive Index Gradient in Glass." U.S. Patent 3,873,408, filed November 9, 1972, and issued March 25, 1975.
- Hiller, Jeri'Ann, Jonas D. Mendelshon, and Michael, F. Rubner. 2002. "Reversible Erasable Nanoporous Anti-Reflection Coatings from Polyelectrolyte Multilayers." *Nature Materials* 1 (1) (September): 59–63. <http://www.nature.com/nmat/journal/v1/n1/pdf/nmat719.pdf>.
- Houde-Walter, Susan N., and Duncan T. Moore. 1986. "Delta-n Control in GRIN Glass by Additives in AgCl Diffusion Baths." *Applied Optics* 25 (19): 3373–3378. <http://dx.doi.org/10.1364/AO.25.003373>.



- Institute for Defense Analyses. 2013. "DARPA BOSS Phase 2 Program Summary Briefing," June 5.
- Jagger, W. S., and P. J. Sands. 1999. "A Wide-Angle Gradient Index Optical Model of the Crystalline Lens and Eye of the Octopus." *Vision Research* 39 (17) (August): 2841–2852. <http://www.sciencedirect.com/science/article/pii/S0042698999000127>.
- Ji, Shanzuo, Kezhen Yin, Matthew Mackey, Aaron Brister, Michael Ponting, and Eric Baer. 2013. "Polymeric Nanolayered Gradient Refractive Index Lenses: Technology Review and Introduction of Spherical Gradient Refractive Index Ball Lenses." *Optical Engineering* 52 (11) (November): 112105-1–112105-13. [http://www.stc-clips.org/site/wp-content/uploads/2013/08/OE\\_52\\_11\\_112105.pdf](http://www.stc-clips.org/site/wp-content/uploads/2013/08/OE_52_11_112105.pdf).
- Jin, Y., H. Tai, A. Hiltner, E. Baer, and James S. Shirk. 2007. "New Class of Bioinspired Lenses with a Gradient." *Journal of Applied Polymer Science* 103 (3): 1834–1841. doi:[10.1002/app.25404](https://doi.org/10.1002/app.25404).
- Kaiser, Peter K. 2009. "The Electromagnetic Spectrum." A Link in Chap. 15, *The Joy of Visual Perception*. <http://www.yorku.ca/eye/spectru.htm>.
- Keck, Donald B., and Robert Olshansky. 1975. "Optical Waveguide Having Optimal Index Gradient." U.S. Patent 3,904,268, filed November 15, 1974, and issued September 9, 1975.
- Kimera LLC. 2013. "Refraction." <http://www.bigshotcamera.com/learn/imaging-lens/refraction>.
- Kipp, L., M. Skibowski, R. L. Johnson, R. Berndt, R. Adelung, S. Harm, and R. Seemann. 2001. "Sharper Images by Focusing Soft X-rays with Photon Sieves." *Nature* 414 (November 8): 184–188. doi:[10.1038/35102526](https://doi.org/10.1038/35102526).
- Kostidas, Panagiotis, Vijay Modi, and Jeffrey M. Gordon. 2011. Gradient-Index Lenses for Near-Ideal Imaging and Concentration with Realistic Materials." *Optics Express* 19 (16) (July): 15584–15595. <http://dx.doi.org/10.1364/OE.19.015584>.
- Kröger, R. H., M. C. Campbell, R. D. Fernald, and H.-J. Wagner. 1999. "Multifocal Lenses Compensate for Chromatic Defocus in Vertebrate Eyes." *Journal of Comparative Physiology A* 184 (4) (April): 361–369. doi:[10.1007/s003590050335](https://doi.org/10.1007/s003590050335).
- Land, Michael F. 2005. "The Optical Structure of Animal Eyes." *Current Biology* 15 (9) (May): R319–R323. <http://www.sciencedirect.com/science/article/pii/S0960982205004410>.
- Land, M. F., and D.-E. Nilsson. 2002. *Animal Eyes*. Oxford, U.K.: Oxford University Press.
- Land, Michael F., and Russel D. Fernald. 1992. "The Evolution of Eyes." *Annual Review of Neuroscience* 15:1–29. doi:[10.1146/annurev.ne.15.030192.000245](https://doi.org/10.1146/annurev.ne.15.030192.000245).
- Leger, James R. 2012. *Gradient-Index Optics for Laser Applications: Final Report*. IDA Document NS D-4675. Alexandria VA: Institute for Defense Analyses.

- Lin, Di, James R. Leger, Mint Kunkel, and Peter McCarthy. 2013. "One-Dimensional Gradient-Index Metrology Based on Ray Slope Measurements Using a Bootstrap Algorithm." *Optical Engineering* 52 (11) (November): 112108-1–112108-10. doi:[10.1117/1.OE.52.11.112108](https://doi.org/10.1117/1.OE.52.11.112108).
- Luneburg, R. K. 1944. *Mathematical Theory of Optics*. Providence, RI: Brown University.
- Mait, Joseph. 2013. "Limits on Gradient-Index Performance for Volume Reduction." DRAFT.
- McCarthy, Peter, and Duncan T. Moore. 2013. "Design and Tolerance Analysis of an Axial Gradient-Index Singlet Broadband Laser Collimator." *Optical Engineering* 52 (11) (November): 112110-1–112110-7. <http://opticalengineering.spiedigitallibrary.org/issue.aspx?journalid=92&issueid=927301>.
- McCarthy, Peter, James Corsetti, Duncan T. Moore, and Greg R. Schmidt. 2012. "Application of a Multiple Cavity Fabry-Perot Interferometer for Measuring the Thermal Expansion and Temperature Dependence of Refractive Index in New Gradient-Index Materials." *Imaging and Applied Optics Technical Digest*. <http://www.opticsinfobase.org/abstract.cfm?URI=OFT-2012-OTu2D.3>.
- Meemon, Panomsak, Jianing Yao, Kye-Sung Lee, Kevin P. Thompson, Michael Ponting, Eric Baer, and Jannick P. Roland. 2013. "Optical Coherence Tomography Enabling Non Destructive Metrology of Layered Polymeric GRIN Material." *Scientific Reports* 3 (Article No. 1709) (April): 1–10. doi:[10.1038/srep01709](https://doi.org/10.1038/srep01709).
- Mendelsohn, J. D., C. J. Berett, V. V. Chan, A. J. Pal, A. M. Mayes, and M. F. Rubner. 2000. "Fabrication of Microporous Thin Films from Polyelectrolyte Multilayers." *Langmuir* 16 (11): 5017–5023. [http://barrett-group.mcgill.ca/publications/full\\_text/12\\_Mendelsohn\\_barrett.pdf](http://barrett-group.mcgill.ca/publications/full_text/12_Mendelsohn_barrett.pdf).
- Michigan Eye Bank. 2010. "Anatomy of the Eye." <http://www.michiganeyebank.org/education/anatomy-of-the-eye.htm>.
- Millodot, Michel, and Jacob Sivak. 1979. "Contribution of the Cornea and Lens to the Spherical Aberration of the Eye." *Vision Research* 19 (6): 685–687. <http://www.sciencedirect.com/science/article/pii/004269897990244X>.
- Mohr, R. K., J. A. Wilder, P. B. Macedo, and P. K. Gupta. 1979. "Gradient Index Lenses by the Molecular Stuffing Process." Technical Digest on Gradient Index Optical Imaging Systems (Paper WA1), Rochester, NY, May 15–16. Washington, D.C.: Optical Society of America.
- Moore, Duncan T. 2010. "Gradient Index Optics." Chapter 24 in *Handbook of Optics: Geometrical and Physical Optics, Polarized Light, Components and Instruments*, 3<sup>rd</sup> ed., Vol. I, edited by Michael Bass, Virendra N. Mahajan, et al., 24.1–24.9. New York: McGraw Hill Professional.
- Moore, Robert S. 1973. Plastic optical element having refractive index gradient. USA Patent 3,718,383, filed April 19, 1971, and issued February 27, 1973.

- New York Carver. 2012. "Medieval Inventions: Eyeglasses."  
<http://www.newyorkcarver.com/inventions.htm>.
- PhotoMoti. 2013. "Who is Moti?" <http://www.photomoti.com/pages/who-is-moti>.
- Ponting, Michael, Anne Hiltner, and Eric Baer. 2010. "Polymer Nanostructures by Forced Assembly: Process, Structure, and Properties." *Macromolecular Symposia* 294 (1) (August): 19–32. doi:[10.1002/masy.201050803](https://doi.org/10.1002/masy.201050803).
- Rodrigues, Vailancio. 2010. "The Showcase of Beautiful Pinhole Photography." *Smashing Magazine*, July 25. <http://www.smashingmagazine.com/2010/07/25/the-showcase-of-beautiful-pinhole-photography/>.
- Schmidt, Olaf, Karl-Heinz Wilms, and Bernd Lingelbach. 1999. "The Visby Lenses." *Optometry and Vision Science* 76 (9) (September): 624–630.  
<http://www.kleinesdorfinschleswig-holstein.de/buerger/oschmi/visby/visbye.htm>.
- Schrenk, W. J., and T. Alfrey, Jr. 1969. "Some Physical Properties of Multilayered Films." *Polymer Engineering and Science* 9 (6) (November): 393–399.  
<http://onlinelibrary.wiley.com/doi/10.1002/pen.760090604/pdf>.
- Shimomura, Hiroomi, Zekeriyya Gemici, Robert E. Cohen, and Michael F. Rubner. 2010. "Layer-by-Layer-Assembled High-Performance Broadband Antireflection Coatings." *ACS Applied Materials & Interfaces* 2 (3) (February): 813–820.  
<http://pubs.acs.org/doi/abs/10.1021/am900883f>.
- Shirk, J. S., M. Sandrock, D. Scribner, E. Fleet, R. Stroman, E. Baer, and A. Hiltner. 2006. "Biomimetic Gradient Index (GRIN) Lenses." *NRL Review*:53–60.  
[https://www.google.com/#q=Shirk%2C+J.+S.%2C+M.+Sandrock%2C+D.+Scribner%2C+E.+Fleet%2C+R.+Stroman%2C+E.+Baer%2C+and+A.+Hiltner.+2006.+%E2%80%9CBiomimetic+Gradient+Index+\(GRIN\)+Lenses&undefined=undefined](https://www.google.com/#q=Shirk%2C+J.+S.%2C+M.+Sandrock%2C+D.+Scribner%2C+E.+Fleet%2C+R.+Stroman%2C+E.+Baer%2C+and+A.+Hiltner.+2006.+%E2%80%9CBiomimetic+Gradient+Index+(GRIN)+Lenses&undefined=undefined).
- Silvestri, A., G. Molin, and G. Salviulo. 2006. "Sand for Roman Glass Production: An Experimental and Philological Study on Source of Supply." *Archaeometry* 48 (3) (August): 415–432. doi:[10.1111/j.1475-4754.2006.00264.x](https://doi.org/10.1111/j.1475-4754.2006.00264.x).
- Sinai, P. 1971. "Correction of Optical Aberrations by Neutron Irradiation." *Applied Optics* 10 (1) (January): 99–104. <http://dx.doi.org/10.1364/AO.10.000099>.
- Siviglia, Nick. 2010. "A History of Contact Lenses." The Edward Hand Medical Heritage Foundation. Accessed October 5, 2013.  
[http://www.edwardhandmedicalheritage.org/history\\_of\\_contact\\_lenses.html](http://www.edwardhandmedicalheritage.org/history_of_contact_lenses.html).
- The British Museum. n.d. "Images." Accessed October 5, 2013.  
<http://www.bmimages.com/preview.asp?image=00564340001&imageex=1&searchnum=0001>.
- "The History of Mirrors." n.d. Accessed October 5, 2013.  
<http://mjgfx.8m.com/Welcome%20to%20Ruby's%20World/RUBYSVILLE/Stories/The%20History%20of%20Mirrors.htm>.
- Tracking Ancient Man. 2012. "Optical Lenses." Accessed October 5, 2013.  
<http://www.ancient-hebrew.org/ancientman/1031.html>.

- Trost, H. J., S. Ayers, T. Chen, W. R. Cox, M. E. Grove, and R. Hoenigman. 2001. "Using Drop-on-Demand Technology for Manufacturing GRIN Lenses." In *Proceedings of the Annual Meeting of the American Society for Precision Engineering (ASPE)*.  
[http://www.aspe.net/publications/Annual\\_2001/PDF/POSTERS/PROCESS/NONCON/1156.PDF](http://www.aspe.net/publications/Annual_2001/PDF/POSTERS/PROCESS/NONCON/1156.PDF).
- Tsiboulia, Andrew B. 2003. "Gradient Index (GRIN) Lenses." In *Encyclopedia of Optical Engineering*, Vol. 1, edited by Ronald G Driggers, 675–685. Monticello, NY: Marcel Dekker, Inc.
- Uhlmann, D. R., T. Suratwala, K. Davidson, J. M. Boulton, and G. Teowee. 1997. "Sol-Gel Derived Coatings on Glass." *Journal of Non-Crystalline Solids* 218 (September 1997): 113–122.  
<http://www.sciencedirect.com/science/article/pii/S0022309397001622>.
- Visconti, Anthony J., and Julie L. Bentley. 2013. "Fabrication of Large-Diameter Radial Gradient-Index Lenses by Ion Exchange of Na<sup>+</sup> for Li<sup>+</sup> in Titania Silicate Glass." *Optical Engineering* 52 (11) (November): 112103-1–112103-6.  
 doi:10.1117/1.OE.52.11.112103.
- Visconti, Anthony J., James A. Corsetti, Kejia Fang, Peter McCarthy, Greg R. Schmidt, and Duncan T. Moore. 2013. "Eyepiece Designs with Radial and Spherical Polymer Gradient-Index Optical Elements." *Optical Engineering* 52 (11) (November): 112102-1–112102-8. doi:10.1117/1.OE.52.11.112102.
- Warren Wilson College. 2007. "Physics Photo of the Week: Road Mirage."  
<http://www.warren-wilson.edu/~physics/PhysPhotOfWeek/2007PPOW/20070921RoadMirage/>.
- Whitehouse, David. 2000. "Did the Vikings Make a Telescope?" *BBC News*, April 5.  
<http://news.bbc.co.uk/2/hi/science/nature/702478.stm>.
- Wikimedia Commons. 2013a. "File:Barlow lens.svg." Last modified April 19, 2013. Accessed October 5, 2013.  
[http://commons.wikimedia.org/wiki/File:Barlow\\_lens.svg](http://commons.wikimedia.org/wiki/File:Barlow_lens.svg).
- Wikimedia Commons. 2013b. "File:Lunenburg lens.svg." Last modified September 1, 2010. Accessed October 5, 2013.  
[http://commons.wikimedia.org/wiki/File:Lunenburg\\_lens.svg](http://commons.wikimedia.org/wiki/File:Lunenburg_lens.svg).
- Wikimedia Commons. 2013c. "File:Maxwells fish-eye lens.svg." Last modified September 1, 2010. Accessed October 5, 2013.  
[http://commons.wikimedia.org/wiki/File:Maxwells\\_fish-eye\\_lens.svg](http://commons.wikimedia.org/wiki/File:Maxwells_fish-eye_lens.svg).
- Wikipedia. 2013a. "Achromatic Lens." Last modified July 10, 2013. Accessed October 5, 2013. [http://en.wikipedia.org/wiki/Achromatic\\_doublet](http://en.wikipedia.org/wiki/Achromatic_doublet).
- Wikipedia. 2013b. "Camera Obscura." Last modified September 16, 2013. Accessed October 5, 2013. [http://en.wikipedia.org/wiki/Camera\\_obscura](http://en.wikipedia.org/wiki/Camera_obscura).
- Wikipedia. 2013c. "Eyepiece." Last modified September 28, 2013. Accessed October 5, 2013. <http://en.wikipedia.org/wiki/Eyepiece>

- Wikipedia. 2013d. "Pinhole Camera." Last modified 1 October 2013. Accessed October 5, 2013. [http://en.wikipedia.org/wiki/Pinhole\\_camera](http://en.wikipedia.org/wiki/Pinhole_camera).
- Wilk, Stephen R. 2004. "Claudius Ptolemy's Law of Refraction." *Optic and Phonics News*, October. <http://www.osa-opn.org/Content/ViewFile.aspx?id=5392>.
- Wood, Robert W. 1905. *Physical Optics*. New York: MacMillan. <https://archive.org/details/physicaloptics00wooduoft>.
- Wu, Zhizhong, Joe Walish, Adam Nolte, Lei Zhai, Robert E. Cohen, and Michael F. Rubner. 2006. "Deformable Antireflection Coatings from Polymer and Nanoparticle Multilayers." *Advanced Materials* 18 (20) (October): 2699–2702. doi:[10.1002/adma.200601438](https://doi.org/10.1002/adma.200601438).
- Zhang, De-Ying, Nicole Justis, and Yu-Hwa Lo. 2005. "Fluidic Adaptive Zoom Lens with High Zoom Ratio and Widely Tunable Field of View." *Optics Communications* 249 (1–3) (May): 175–182. doi:[10.1016/j.optcom.2005.01.010](https://doi.org/10.1016/j.optcom.2005.01.010).
- Zhang, De-Ying, Nicole Justis, and Yu-Hwa Lo. 2004. "Fluidic Adaptive Lens of Transformable Lens Type." *Applied Physics Letters* 84 (21) (May): 4194–4196. [http://apl.aip.org/resource/1/applab/v84/i21/p4194\\_s1](http://apl.aip.org/resource/1/applab/v84/i21/p4194_s1).
- Zhang, De-Ying, Victor Lien, Yevgeny Berdichevsky, Jaehyuck Choi, and Yu-Hwa Lo. 2003. "Fluidic Adaptive Lens with High Focal Length Tunability." *Applied Physics Letters* 82 (19) (May): 3171–3172. <http://dx.doi.org/10.1063/1.1573337>.
- Zheng, Haixing. 1995. *Refractive Index Gradient (GRIN) Lens via the Sol-Gel Process*. Final Report. Northridge, CA: Chemat Technology, Inc. <http://www.dtic.mil/cgi-bin/GetTRDoc?AD=ADA301106>.
- Zuccarello, Guido, Dean Scribner, Randall Sands, and Leonard J. Buckley. 2002. "Materials for Bio-inspired Optics." *Advanced Materials* 14 (18) (September): 1261–1264. [http://onlinelibrary.wiley.com/doi/10.1002/1521-4095\(20020916\)14:18%3C1261::AID-ADMA1261%3E3.0.CO;2-N/pdf](http://onlinelibrary.wiley.com/doi/10.1002/1521-4095(20020916)14:18%3C1261::AID-ADMA1261%3E3.0.CO;2-N/pdf).



## Bibliography

---

- Beadie, G., E. Fleet, A. Rosenberg, Paul A. Lane, James S. Shirk, A. R. Kamdar, M. Ponting, et al. "Gradient Index Polymer Optics." *Proceedings of SPIE* 7061 (August 2008): 706113-1–706113-5. doi:[10.1117/12.795906](https://doi.org/10.1117/12.795906).
- Beadie, G., E. Fleet, James S. Shirk, A. Hiltner, and E. Baer. "Bio-Inspired Polymer Optics." *Proceedings of SPIE* 7397 (August 2009): 739708-1–739708-5. doi:[10.1117/12.827517](https://doi.org/10.1117/12.827517).
- Beadie, G., James S. Shirk, A. Rosenberg, Paul A. Lane, E. Fleet, A. R. Kamdar, Y Jin, et al. "Optical Properties of a Bio-Inspired Gradient Refractive Index Polymer Lens." *Optics Express* 16, no. 15 (2008): 11540–11547. <http://www.opticsinfobase.org/oe/abstract.cfm?uri=oe-16-15-11540>.
- Brindza, Michael, A. Rosenberg, G. Beadie, James S. Shirk, M. Ponting, and E. Baer. "Refractive Index of Nanolayered Polymeric Optical Materials." Paper presented at the Conference on Lasers and Electro-Optics (CLEO): Applications and Technology, Baltimore, MD, May 1–6, 2011. [http://ieeexplore.ieee.org/xpls/abs\\_all.jsp?arnumber=5951208](http://ieeexplore.ieee.org/xpls/abs_all.jsp?arnumber=5951208).
- Buckley, Leonard, Randall Sands, Dean Scribner, and Guido Zuccarello. "Technology Imitates Life." *oemagazine*, September 2004. <http://spie.org/x16553.xml>.
- Corsetti, James A., Leo R. Gardner, Greg. R. Schmidt, and Duncan T. Moore. "Athermalization of Polymer Radial Gradient-Index Singlets." *Optical Engineering* 52, no. 11 (November 2013): 112104-1–112104-6. <http://opticalengineering.spiedigitallibrary.org/issue.aspx?journalid=92&issueid=927301>.
- Corsetti, James A., Peter McCarthy, and Duncan T. Moore. "Color Correction in the Infrared Using Gradient-Index Materials." *Optical Engineering* 52, no. 11 (November 2013): 112109-1–11210-6. <http://opticalengineering.spiedigitallibrary.org/issue.aspx?journalid=92&issueid=927301>.
- Hecht, Jeff. "Magic Eyes." *New Scientist* 181, no. 2431 (January 24, 2004): 24–27.
- Higginson, Keith A., Michael A. Costolo, and Edward Rietman. "Adaptive Geometric Optics Derived from Nonlinear Acoustic Effects." *Applied Physics Letters* 84, no. 6 (9 February 2004): 843–845. <http://dx.doi.org/10.1063/1.1645663>.
- Higginson, Keith A., Michael A. Costolo, Edward A. Rietman, Joseph M. Ritter, and Bart Lipkens. "Tunable Optics Derived from Nonlinear Acoustic Effects." *Journal of Applied Physics* 95, no. 10 (2004): 5896–5904. <http://dx.doi.org/10.1063/1.1697618>.

- Ji, Shanzuo, Michael Ponting, Richard S. Lepkowicz, Armand Rosenburg, Richard Flynn, Guy Beadie, and Eric Baer. "A Bio-Inspired Polymeric Gradient Refractive Index (GRIN) Human Eye Lens." *Optics Express* 20, no. 24 (19 November 2012): 26746–26754. <http://www.opticsinfobase.org/oe/abstract.cfm?uri=oe-20-24-26746>.
- Lai, Chuan-Yar, Michael T. Ponting, and Eric Baer. "Influence of Interdiffusion on Multilayered Gradient Refractive Index (GRIN) Lens Materials." *Polymer* 53, no. 6 (March 2012): 1393–1403. <http://www.sciencedirect.com/science/article/pii/S0032386112000638#>.
- Liu, Richard Y. F., Yi Jin, Anne Hiltner, and Eric Baer. "Probing Nanoscale Polymer Interactions by Forced-Assembly." *Macromolecular Rapid Communications* 24, no. 16 (2003): 943–948. doi:[10.1002/marc.200300051](https://doi.org/10.1002/marc.200300051).
- Lo, Yu-Hwa. *Adaptive Lens Inspired by Bio-Visual Systems*. La Jolla, CA: University of California San Diego, Electrical and Computer Engineering Department, October 2004. <http://oai.dtic.mil/oai/oai?verb=getRecord&metadataPrefix=html&identifier=ADA426945>.
- Sandrock, Marie, Michael Wiggins, James S. Shirk, Huiwen Tai, Aditya Rande, Eric Baer, and Anne Hiltner. "A Widely Tunable Refractive Index in a Nanolayered Photonic Material." *Applied Physics Letters* 84, no. 18 (3 May 2004): 3621–3623. <http://dx.doi.org/10.1063/1.1738513>.
- Schmidt, Greg. R. "Compound Optical Arrays and Polymer Tapered Gradient Index Lenses." Submitted in Partial Fulfillment of the Requirements for the Degree of Doctor of Philosophy, University of Rochester, NY, 2009. <https://urresearch.rochester.edu/institutionalPublicationPublicView.action?institutionalItemId=7363&versionNumber=1>.
- Shatz, Narkis. *Gradient-Index optics Final Report*. San Diego, CA: Science Applications International Corporation (SAIC), 2011. <http://www.dtic.mil/cgi-bin/GetTRDoc?AD=ADA546662>.
- Shirk, James S., Guy Beadie, Richard S. Lepkowicz, Y. Jin, E. Baer, and A. Hiltner. "Biomimetic Optical Polymers." Paper presented at the Conference on Lasers and Electro-Optics (CLEO): Applications and Technology, Baltimore, MD, May 1–6, 2011. <http://www.opticsinfobase.org/abstract.cfm?uri=CLEO-2007-CThD1>.
- Stroman, Richard O. *Mechanical Design Report: DARPA BOSS Program*. Report No. NRL/MR/6110—08-9116. Washington, DC: Naval Research Laboratory, 2008. <http://www.dtic.mil/cgi-bin/GetTRDoc?AD=ADA480485>.
- Teichman, Jeremy A. "Measurement of Gradient Index Materials by Beam Deflection, Displacement, or Mode Conversion." *Optical Engineering* 52, no. 11 (November 2013): 112112-1–112112-8. <http://opticalengineering.spiedigitallibrary.org/issue.aspx?journalid=92&issueid=927301>.



- Teichman, Jeremy A. *Measurement of Gradient Index Materials by Berm Deflection, Displacement, or Mode Conversion*. IDA Paper NS P-4994. Alexandria VA: Institute for Defense Analyses, 2013. <https://www.ida.org/upload/pubsstd/ida-paper-ns-p-4994-final-s001.pdf>
- Visconti, Anthony J., and Julie L. Bently. "Design of Radial Gradient-Index Lenses for Dual-Band Visible to Short-Wave Infrared Imaging Systems." *Optical Engineering* 52, no. 11 (November 2013): 112106-1–112016-9. <http://opticalengineering.spiedigitallibrary.org/issue.aspx?journalid=92&issueid=927301>.
- Visconti, Anthony J., Duncan T. Moore, and Julie L. Bently. "Large Diameter Radial Gradient-Index Lenses Fabricated by Ion Exchange." Paper presented at the Conference on Imaging Systems and Applications, Monterey, CA, June 24–28, 2012. <http://dx.doi.org/10.1364/ISA.2012.IM2C.2>.
- Visconti, Anthony J., Kejia Fang, James A. Corsetti, Peter McCarthy, Greg R. Schmidt, and Duncan T. Moore. "Design and Fabrication of a Polymer Gradient-Index Optical Element for a High-Performance Eyepiece." *Optical Engineering* 52, no. 11 (November 2013): 112107-1–112017-9. <http://opticalengineering.spiedigitallibrary.org/issue.aspx?journalid=92&issueid=927301>.
- Yao, Jianing, Panomsak Meemon, Kye-Sung Lee, and Jannick P. Rolland. "Nondestructive Metrology by Optical Coherence Tomography Empowering Manufacturing Iterations of Layered Polymeric Optical Materials." *Optical Engineering* 52, no. 11 (November 2013): 112111-1–112111-9. <http://opticalengineering.spiedigitallibrary.org/issue.aspx?journalid=92&issueid=927301>.



## Abbreviations

---

3D	three-dimensional
AFRL	Air Force Research Laboratory
AION	Aluminum Oxy-Nitride
BOSS	Bio-Optic Synthetic Systems
CNRI	Corporation for National Research Initiatives
CVD	chemical vapor deposition
CWRU	Case Western Reserve University
DARPA	Defense Advanced Research Projects Agency
DLL	dynamic-link library
EM	electromagnetic
FOV	field of view
GRIN	gradient index
IDA	Institute for Defense Analyses
IR	infrared
ITC	International Technology Center
LC	liquid crystal
LRIP	low rate initial production
LWIR	long-wave infrared
MEMS	microelectromechanical systems
M-GRIN	Manufacturable Gradient Index Optics
MIT	Massachusetts Institute of Technology
MRL	Manufacturing Readiness Level
MWIR	mid-wave infrared
NDE	non-destructive evaluation
NG	Northrop Grumman Corporation
NIR	near infrared
NRL	Naval Research Laboratory
OCT	optical coherence tomography
OPD	optical path distance
OSU	The Ohio State University
Pb	lead
PDMS	polydimethylsiloxane
PMMA	polymethyl-methacrylate
PS	polystyrene
RPO	Rochester Precision Optics
SAIC	Science Applications International Corporation
SAN	styrene-acrylonitrile
SLM	spatial light modulator
STD	Science and Technology Division
STO	Strategic Technology Office

SWIR	short wave infrared
TO	transformation optics
UAV	unmanned aerial vehicle
UR	University of Rochester
UV	ultraviolet
$\Delta n$	refractive index range

**REPORT DOCUMENTATION PAGE***Form Approved*  
OMB No. 0704-0188

The public reporting burden for this collection of information is estimated to average 1 hour per response, including the time for reviewing instructions, searching existing data sources, gathering and maintaining the data needed, and completing and reviewing the collection of information. Send comments regarding this burden estimate or any other aspect of this collection of information, including suggestions for reducing the burden, to Department of Defense, Washington Headquarters Services, Directorate for Information Operations and Reports (0704-0188), 1215 Jefferson Davis Highway, Suite 1204, Arlington, VA 22202-4302. Respondents should be aware that notwithstanding any other provision of law, no person shall be subject to any penalty for failing to comply with a collection of information if it does not display a currently valid OMB control number.

**PLEASE DO NOT RETURN YOUR FORM TO THE ABOVE ADDRESS.**

1. REPORT DATE November 2013		2. REPORT TYPE Final		3. DATES COVERED (From–To) January 2010 – November 2013	
4. TITLE AND SUBTITLE  Gradient Index Optics at DARPA				5a. CONTRACT NUMBER W91WAW-09-C-0003	
				5b. GRANT NUMBER	
				5c. PROGRAM ELEMENT NUMBER	
6. AUTHOR(S) Jeremy Teichman Jenny Holzer Bohdan Balko Brent Fisher Leonard Buckley				5d. PROJECT NUMBER	
				5e. TASK NUMBER DA-2-3226	
				5f. WORK UNIT NUMBER	
7. PERFORMING ORGANIZATION NAME(S) AND ADDRESS(ES)  Institute for Defense Analyses 4850 Mark Center Drive Alexandria, VA 22311-1882				8. PERFORMING ORGANIZATION REPORT NUMBER  IDA Document D-5027 Log: H 13-001347/1	
9. SPONSORING / MONITORING AGENCY NAME(S) AND ADDRESS(ES)  Defense Advanced Research Projects Agency Strategic Technology Office 675 North Randolph Street Arlington, VA 22203-2114				10. SPONSOR/MONITOR'S ACRONYM(S)  DARPA	
				11. SPONSOR/MONITOR'S REPORT NUMBER(S)	
12. DISTRIBUTION/AVAILABILITY STATEMENT  Approved for public release; distribution is unlimited.					
13. SUPPLEMENTARY NOTES In the event permission is required, DARPA is authorized to reproduce the copyrighted material for use as an exhibit or handout at DARPA-sponsored events and/or to post the material on the DARPA website.					
14. ABSTRACT The Defense Advanced Research Projects Agency (DARPA) is interested in developing optical materials and related technologies to meet the challenge of cost-effective, reproducible, large-scale manufacturing. Modern optical systems have many individual lens elements and are often complex, bulky, and heavy. In 2002, DARPA initiated the Bio-Optic Synthetic Systems (BOSS) program, which was aimed at simplifying complex optical sensors. The goal of the program was to understand and synthesize the components of a biologically inspired vision system that would demonstrate a level of performance beyond standard optical imaging systems, with reduced size and complexity. Under the BOSS program, DARPA focused its interest on the nanolayer GRIN lens technology. Out of more than a dozen exploratory efforts, four were selected for further development and demonstration: fluidic adaptive zoom lenses, foveated imaging, photon sieves, and nanolayer lenses. However, limited manufacturing capabilities still hindered the practical applications of GRIN lenses. In 2008, DARPA initiated the Manufacturable Gradient Index Optics (M-GRIN) program to address the development of low-cost, customizable GRIN-based optics for use in a variety of military systems. This document briefly outlines the history of optical instruments, addresses bio-inspiration in optics (relying on exploiting what has been developed by nature) and nanolayer GRIN lens technology, and concludes with a discussion of the M-GRIN program.					
15. SUBJECT TERMS  bio-inspired optics, gradient Index of refraction (GRIN), GRIN optics, manufacturing readiness, nanolayer lens					
16. SECURITY CLASSIFICATION OF:			17. LIMITATION OF ABSTRACT  SAR	18. NUMBER OF PAGES  64	19a. NAME OF RESPONSIBLE PERSON Michael Maher
a. REPORT Uncl.	b. ABSTRACT Uncl.	c. THIS PAGE Uncl.			19b. TELEPHONE NUMBER (include area code) (571) 218-4583